

# 2D-CMOS Detector

ELECTRON DETECTOR WITH HIGH SPEED CMOS  
CAMERA AND GRAPHICS PROCESSING UNIT

## KEY FEATURES

- MCP Chevron assembly with fast phosphorous screen
- High speed CMOS camera
- Parallel true pulse counting by Graphics Processing Unit
- Dynamic range  $> 10^6$
- Noise  $< 3$  cps / Detector area

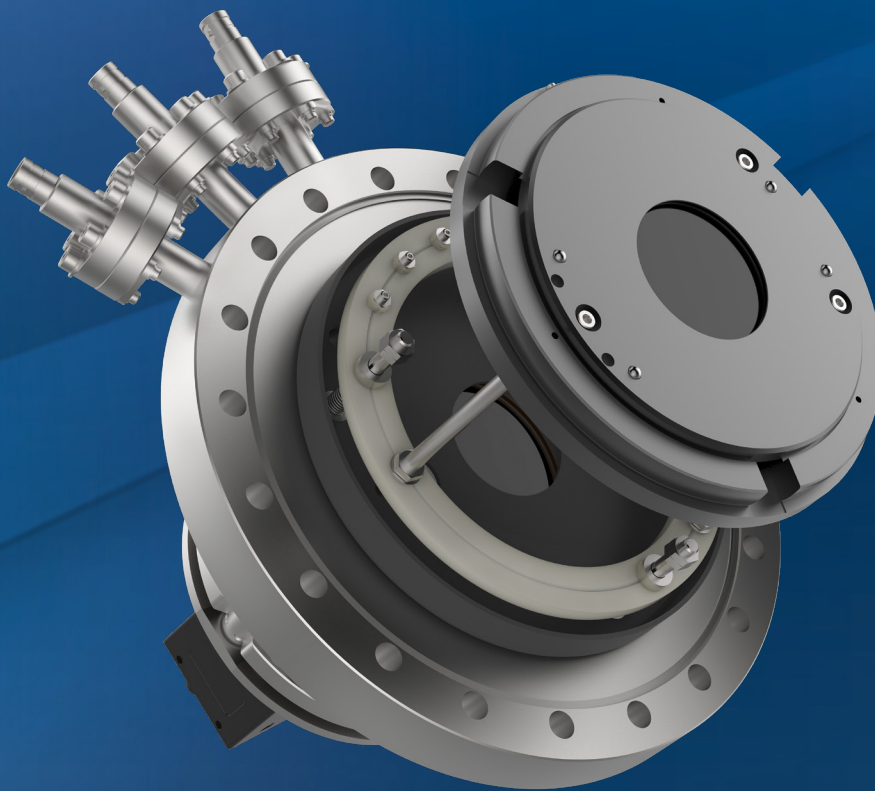

**SPECS**<sup>™</sup>

A member of SPECSGROUP

## SPECS leads the way in developing cutting-edge components and systems for groundbreaking new surface analysis tools.

### SPECS Surface Nano Analysis GmbH

SPECS Surface Nano Analysis GmbH headquarters is situated in the center of Germany's capital Berlin with subsidiaries in Switzerland, USA and China. SPECS has attracted a talented team of scientists and engineers who have dedicated their knowledge and experience to the development, design, and production of instruments for surface science, materials research, and nanotechnology for almost 30 years.

Assembly of a system component for final testing



SPECS engineer during electron detector mounting

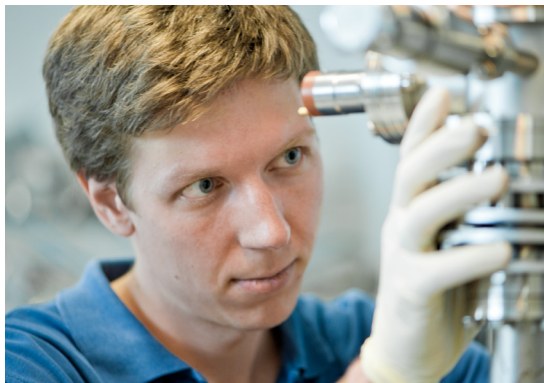

In order to continuously improve performance and to make available latest developments, we are in contact with numerous scientists, users and customers from all over the world. Reliable quality control (ISO 9001 certified) and excellent fast service, both remote and on-site, ensures maximum uptime and long-term operation and reliability of SPECS instruments over many years.

# 2D-CMOS Detector

NEXT GENERATION ELECTRON DETECTOR FOR ANGLE RESOLVED PHOTOELECTRON SPECTROSCOPY (ARPES)

## Two dimensional MCP Detector with High Speed CMOS Camera and Graphics Processing Unit

### 2D-CCD Detectors

#### Technical Concept

An MCP chevron assembly with a phosphor screen is used for electron detection. A single electron enters the MCP stack, being accelerated and multiplied. This packet of electrons (representing a single electron or event) then impinges onto the phosphor coating on the screen causing fluorescence. A camera is recording the entire phosphor screen image. In general MCP-phosphor stack

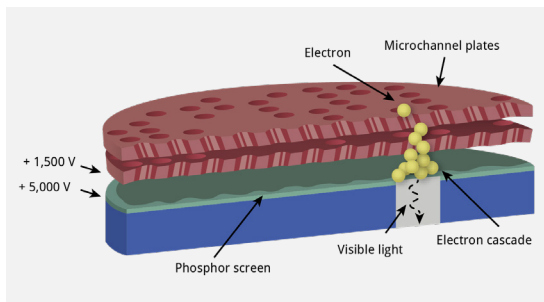

Detection principle of MCP chevron stack with phosphor screen

detectors have an unrivaled homogeneity, but also an inherent non-linearity in the process of detection. A single electron becomes a cascade of varying number of electrons. Through this, there is no one-to-one intensity correspondence with the input electron, and instead the cascade has a spread that is defined by MCP shape and voltage. This inherent non-linearity leads in part to the resulting phosphor light to be non-linear in its response to electrons. This problem persists into the measured spectral intensity, as the intensity measured by the camera is the phosphor

light intensity. In addition to non-linearity, conventional detection schemes that measure the light intensity of the phosphor in the detection stack are susceptible to phosphor blooming. It is possible that the phosphor itself has a non-linear and a spatially extended response which can negatively influence the data. The standard detector for ARPES nowadays works with CCD camera mounted to the detector, allowing for excellent lateral (=angle and energy) resolutions. It can be operated in an analog mode in which the integrated light intensity is used for counting, or in pulse counting mode in which individual light blobs are detected. Both modes as used in standard CCD detectors have disadvantages. In pulse counting mode conventional CCD detectors show saturation at high count rates. In analog mode the detection is non-linear at low count rates.

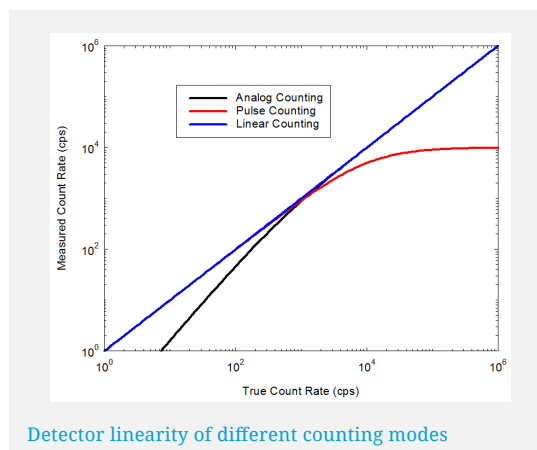

Detector linearity of different counting modes

---

## The new 2D-CMOS Detector

### Detection Principle

To overcome these limitations SPECS presents a new generation of 2D imaging detectors for highest resolution electron spectroscopy. The new detector features a superior dynamic range and an extremely low noise level. The detection concept was developed in the group of Dan Dessau (University of Colorado). It is a true pulse counting algorithm converting the analog light signal to discriminated events. In order to be useful, this pulse counting algorithm must be able to keep up with the rate of events in usual experiments. To do this, the traditional CCD camera is replaced with a high-speed CMOS camera. To keep up with the high data volume the data is processed in a highly parallel environment on a Graphics Processing Unit (GPU).

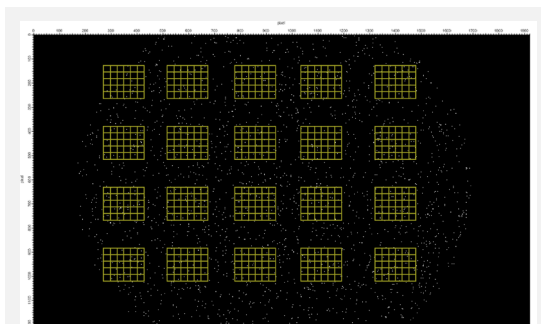

Detection principle: the multiple CPU cores of the GPU process sub-images as sections of the whole image in parallel

### CMOS Camera

The latest improvements in semiconductor technology have greatly increased the capabilities of CMOS sensor. The used camera system features a Sony's IMX174 CMOS sensor. The fast 1/1.2" CMOS offers a resolution of 1920x1200 pixels and frame rates up to 160 fps. This sensor offers the extreme sensitivity required for the lowest light situations while providing superior signal-to-noise ratio, resolution, field-of-view, and frame rates.

### Dynamic Range and Maximum Count Rate

The dynamic range of the new imaging detector has been determined by XPS electron spectroscopy. The measured count rate has been plotted against the sample current. For this, the detector was mounted to a PHOIBOS 225 analyzer. The dynamic range is given by the minimum and maximum measured count rate being in the linear regime. It is shown in the figures on the right side that the new high speed imaging detector is linear at least in a dynamic range of  $10^6$  and it can detect events linearly from 4 cps to 4 Mcps.

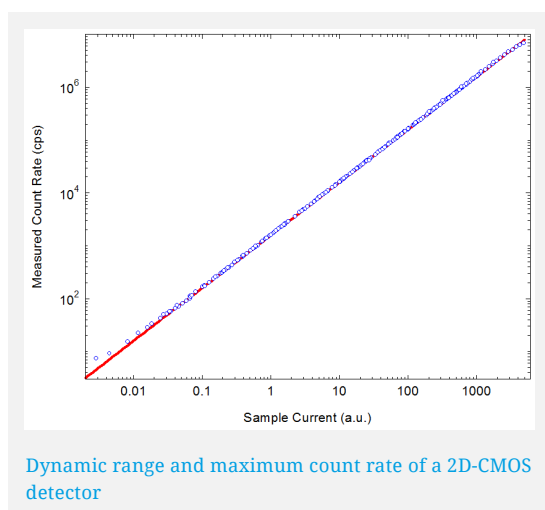

## Noise Level

No background subtraction was done. The offset due to constant dark noise (originating from spontaneous emission of counts from the MCPs) is visible in the data points for lowest count rates. The background count rate is about 2.8 cps across the detector (0.0015 cps/energy channel).

## Performance

### ARPES Data

Bismuth strontium calcium copper oxide (BSCCO), also known as cuprates, is a family of high-temperature superconductors having the generalized chemical formula  $\text{Bi}_2\text{Sr}_2\text{Ca}_{n-1}\text{Cu}_n\text{O}_{2n+4+x}$ , with  $n=2$  being the most commonly studied compound (Bi-2212). The data were measured using a PHOIBOS 225 analyzer equipped with the new high speed 2D-CMOS imaging detector.

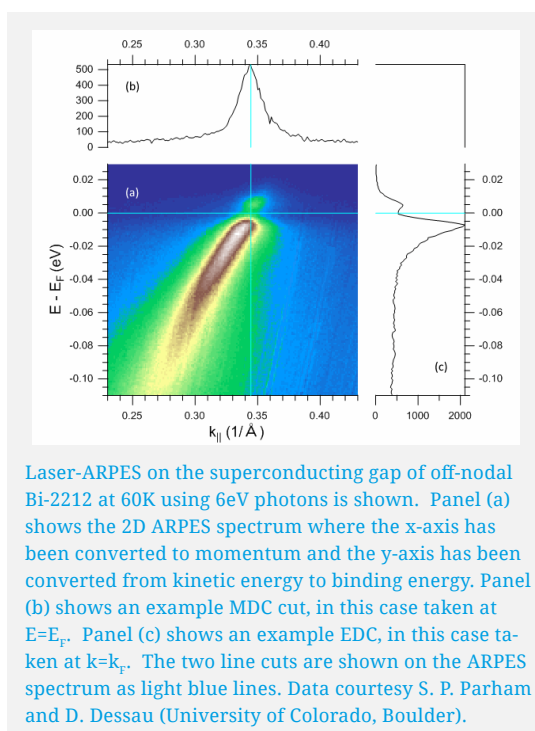

# PHOIBOS Series

ULTIMATE PERFORMANCE ELECTRON ENERGY ANALYZERS

## PHOIBOS 100/150/225

### Design and Concept

The latest design of the PHOIBOS hemispherical energy analyzer is currently in its 7th generation. Even though the design of the hemispherical analyzers has not significantly changed during the last 25 years of solid state physics, their performance still reaches outstanding values with modern electronics and light sources. The long term experience combined with modern electronics allows to study the materials properties with extremely high quality. SPECS permanently continues to improve the PHOIBOS series without touching the well-established and proven standards on the hemispherical analyzer type. The PHOIBOS analyzer is the standard state-of-the-art analyzer model for various analysis methods such as XPS/UPS and ARPES, as well as AES, ISS and microscopy solutions. It comes in three sizes: 100mm mean radius, 150mm and

225mm, with increasing transmission efficiency and energy resolution. All analyzers are capable of all standard detectors and the 150/225 are in addition capable of being equipped with spin detectors. The awarded design of the analyzer is set up from a sophisticated lens system, providing real raw data with high transmission and a stable hemispherical energy analyzer design. The hardware is run by a highly stable and reliable electronics. The standard configuration allows the detection of up to 3.5 kV. For high energy analysis, HV versions of the PHOIBOS 150 and 225 analyzers are available.

The new 2D-CMOS detector is also retrofittable to existing PHOIBOS analyzers, not being limited to the latest release. Thus the performance can significantly improve by just exchanging the detector.



PHOIBOS 150 2D-CMOS

### Electronics

The HSA electronics for the control of the SPECS analyzer series is a reliable and versatile control unit for photoelectron spectroscopy. The modular design of the power supply configuration can be used for different applications such as standard ARPES/XPS analyzers, but also for NAP analyzers and Spin detectors. Customized configurations for special applications are available on demand.

To account for the various experiments the HSA comes in three basic versions: the +/- 3.5 kV version and the high voltage 7 kV and 15 kV versions. Special HSA versions for Spin detectors are included in the detector packages. The HSA is a bipolar power supply, allowing to control photoelectron experiments as well the processing of ions inside the analyzer for ISS spectroscopy.



HSA 3500+ Electronics

## Technical Data

### Specifications

2D-CMOS Detector	
Count rate linearity range	> $6 \times 10^6$ cps
Noise	< 3 cps full detector area < 0.002 cps per energy channel
Dynamic Range	> $10^6$
Typical lateral resolution	< 60 $\mu\text{m}$
Channels	1920x1200
Binning	1,2,3,4,5,6,8 and 10
Frame Rate	160 fps
Multi Hit Capability	> 5000 (within 40 fs)
MCP Stack	Chevron, Imaging Quality, 2d end spoiling
Phosphorus	$\text{Gd}_2\text{O}_2\text{S:Tb}$ (P 43), decay time (90% to 10%) 1 ms

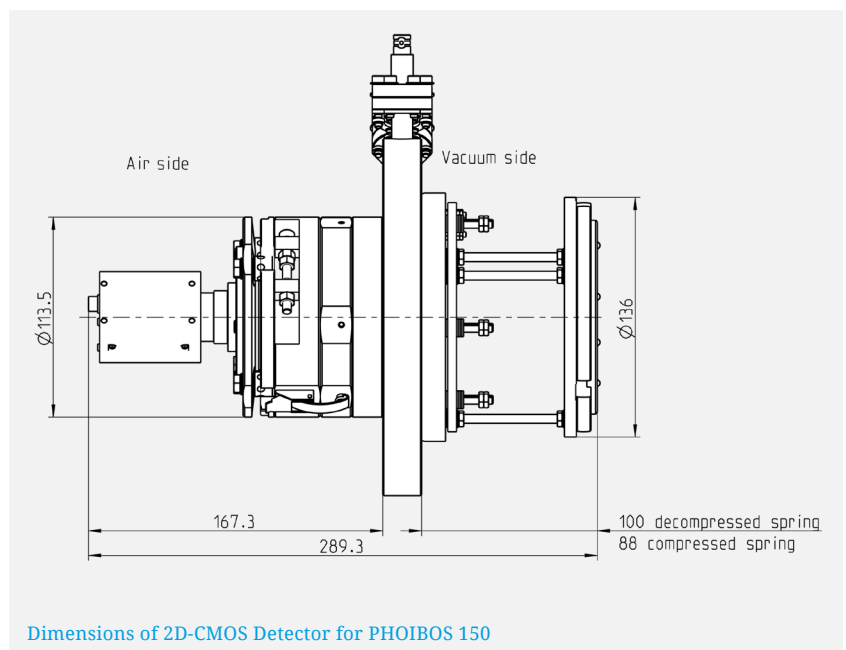

---

c/o **SPECS** Surface Nano Analysis GmbH  
Voltastrasse 5  
13355 Berlin / Germany  
[www.specs-group.com](http://www.specs-group.com)

T +49 (0)30 46 78 24-0  
F +49 (0)30 46 42 083  
E [imfo@specs.com](mailto:imfo@specs.com)

Version 02.05

**SPECSGROUP**