

# Nanonis Tramea™

QUANTUM TRANSPORT MEASUREMENT SYSTEM

## KEY FEATURES

- Powerful, Ultrafast Measurement Solution
- Excellent Signal Performance
- Superior and Customizable User Interface
- Automated Signal Acquisition and Data Processing

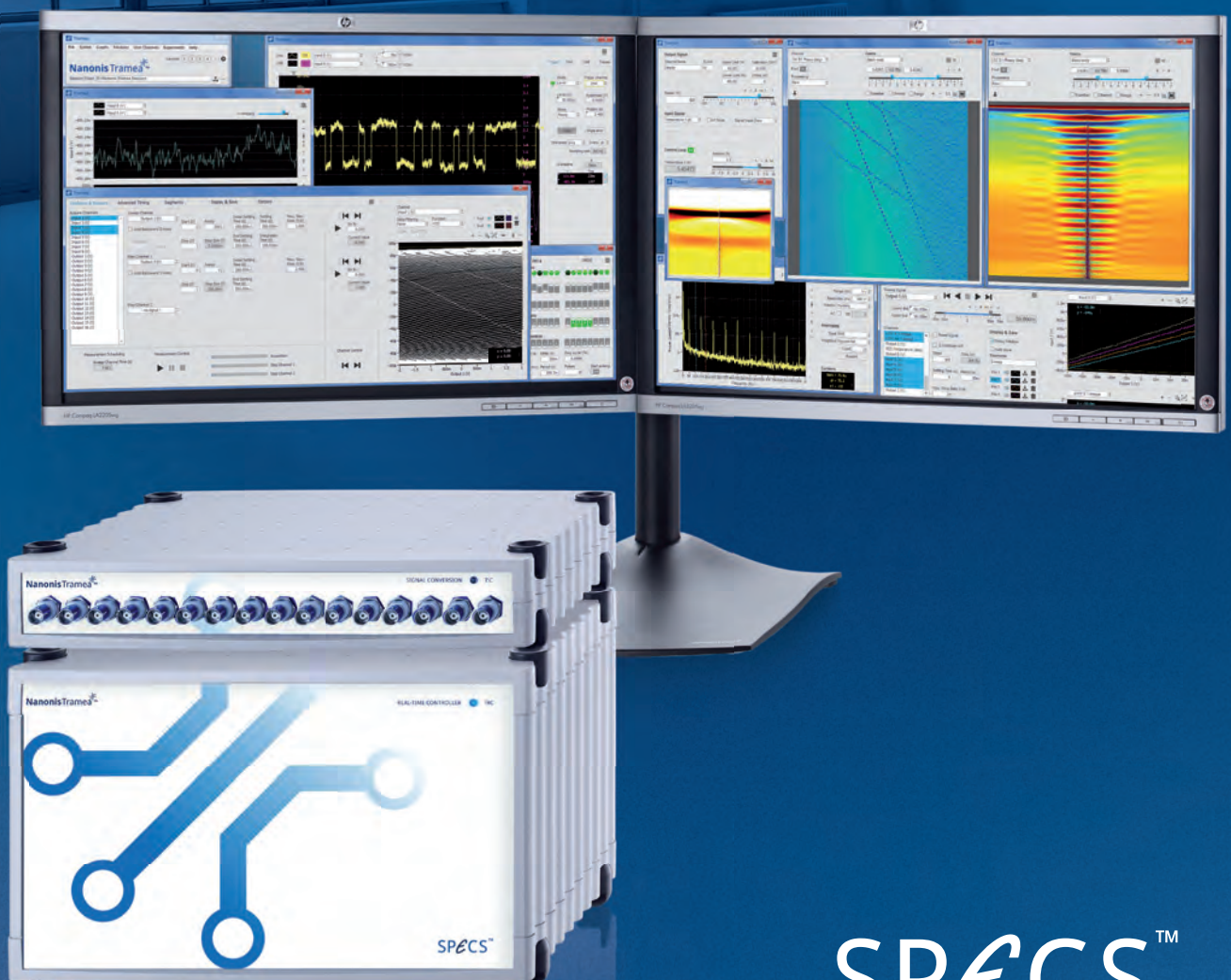

SPÉCS™

## SPECS leads the way in state-of-the-art electronic control and measurement systems for nanotechnology

Development of  
Nanonis Software



State-of-the-art electronic  
design for superior signal  
performance

### SPECS Surface Nano Analysis GmbH

SPECS has more than 150 employees at its headquarters in Berlin and its subsidiaries in the USA and Switzerland. The company also has sales offices in Spain and BeNeLux. Through the international sales channels customers in sixteen countries are supported. A team of scientists and engineers is involved in developing and producing scientific instruments for surface analysis, materials science and nanotechnology. Since the

company has been founded in 1983, its success is based on a continuous gain in experience. SPECS experts are in close contact to a large number of customers and scientists around the world. SPECS is your essential partner in scientific instrumentation due to our focus on customer satisfaction, know-how and international contacts. Scientists all over the world can rely on SPECS high quality products and be inspired by the continuous development of new innovative solutions.

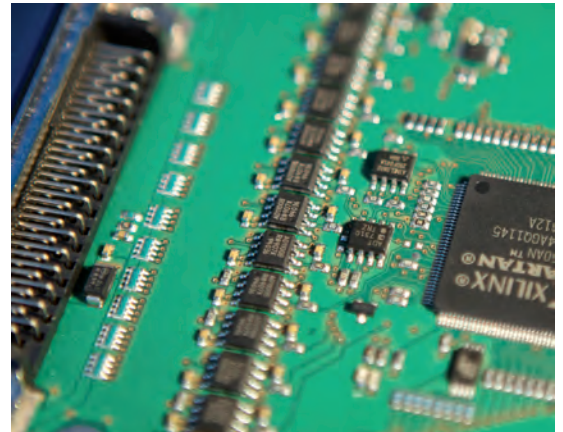

---

# Nanonis Tramea

YOUR SOLUTION FOR TRANSPORT MEASUREMENTS

## Introduction

Nanonis Tramea approaches a new way of working providing precise, fast and high-quality measurements. At the same time the handling of applications is superior and more versatile in performance compared to commonly used laboratory equipment. Tramea is a leading example in efficiency gain for the utilization and maximum capacity of controlling hardware with high sampling data rates suitable for time-resolved measurements and producing volumes of data. This empowers pioneering scientists to benefit from Tramea for scientific research challenges like high-throughput investigations or quantum transport measurements.

Nowadays you do not need to choose whether the research characterization has high resolution performance (at the cost of the measurement speed) or fast data acquisition (suffering from lower resolution). Tramea is a unique measurement system providing a combination of precision, accuracy, low noise and low drift with high speed. The result is an excellent Signal-to-Noise performance, highest yield of results and ultimate resolution performance.

Best-in-class research is achievable by the software based instrument Tramea with software features for simple signal handling through a powerful and customizable user interface. The stable software and hardware performance is a new benchmark though having a small and compact footprint.

## Full Flexibility at Reduced Complexity

The experimental complexity associated with quantum transport measurements is reflected in the typical measurement set-ups used in most laboratories: A 19" rack containing multiple single-function instruments like DC sources, lock-in amplifiers, multimeters, oscilloscopes etc. Frequent switching of those hardware connections bears the risk of damaging the sample by disconnecting or connecting cables. Additionally, potential cable tangles can lead to ground loops or signal degradation.

These scenarios belong to the past by working with Tramea being a plug & play tool that can be installed close to the experimental set-up. Therefore the use of short cables is an advantage that avoids signal degradation.

With the high-resolution AD/DA conversion, signal conditioning and fast signal processing Tramea is a future-proof substitution for traditional instruments. It is a complete solution providing advanced data optimization algorithms, a high flexibility for customization and a powerful framework which can be further adapted and extended with a wide range of add-on modules to grow your instrumentation and research application space.

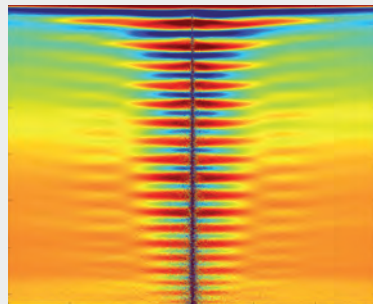

**Quantum Point Contact differential transconductance as a function of source-drain and gate voltage at 70 mK of a GaAs/AlGaAs heterostructure ( $n=1 \times 10^{11} \text{ cm}^{-2}$ ,  $\mu=4 \times 10^6 \text{ cm}^2/(\text{Vs})$ )**

The picture is courtesy of S. Hannel, Nanophysics group of Prof. Klaus Ensslin, ETH Zurich, Switzerland.

## Fully Integrated Digital System

All analog signals are converted immediately into the digital domain where all signal processing is performed. By this no interference with external noise or crosstalk is possible.

The free configurable inputs and outputs (for signal generation, detection and feedback) can be controlled simultaneously by software being optimal for many applications like quantum transport measurements etc.. There is a maximum of 24 channels to be acquired simultaneously and independently. They can be chosen from a total number of 48 channels.

The seamless integration of all relevant components into a single fully digital system significantly improves sample safety and reduces measurement complexity, because there is no need for disconnecting cables when the experimental configuration is changed. The fully digital system is so flexible and scalable, because software adaptations are all which is required to make rapid custom developments of the system working. Therefore, for newly defined experiments the configuration can be changed on the fly.

## Ultrafast Measurement Speed

Nanonis Tramea is a quantum leap with respect to increased speed for transport measurements taking research onto a new level. Measurements which took several hours in the past can now be done in minutes without compromising signal quality. Tramea uses its fast, high-resolution, high-precision and ultra-low-noise outputs and inputs to generate and acquire up to 20000 data points

per second on 24 channels in parallel. This is not only up to 1000 x faster than typical measurement systems but it is also time deterministic with highest precision. Here, the time separation between points is constant so that artefacts caused by unequal point spacings in non-deterministic measurement systems are avoided. The emphasis here is the real-time relation.

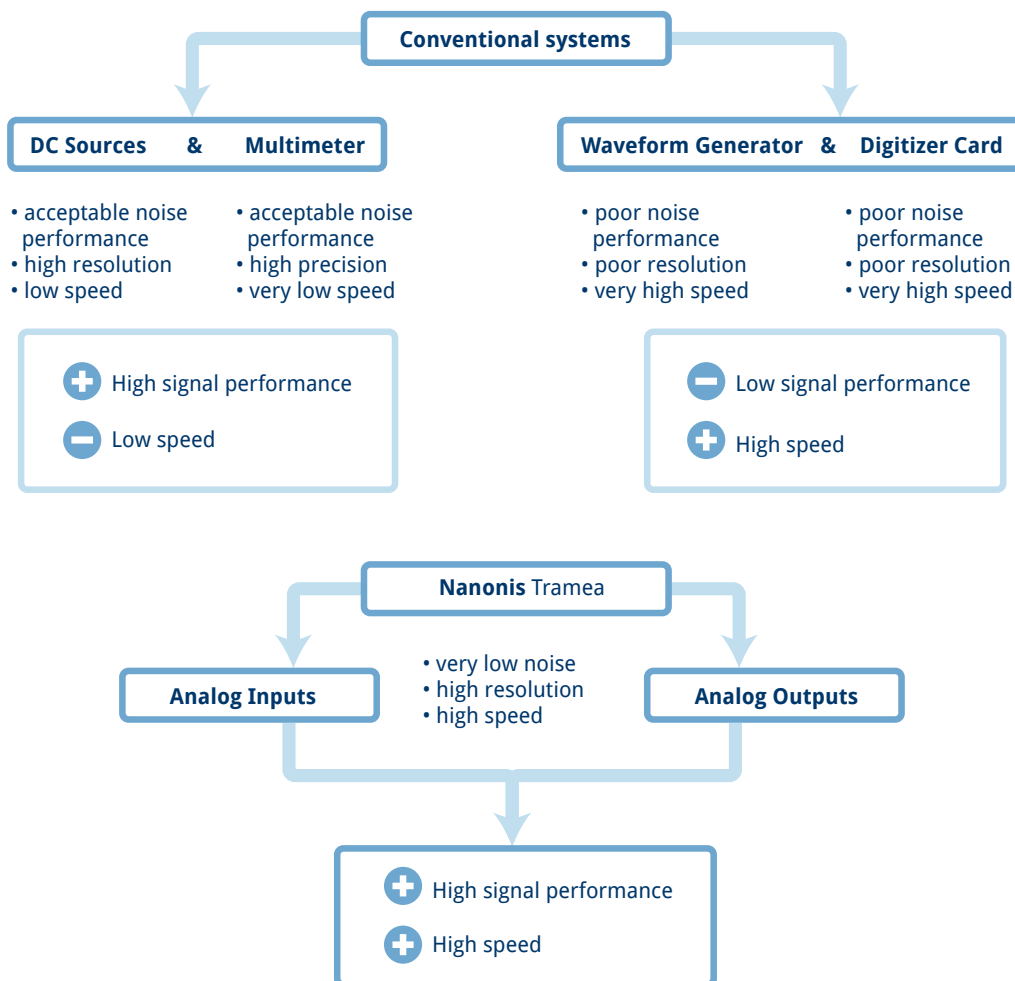

Compared to conventional systems, Tramea combines high signal performance and high speed.



Simplified block diagram of the Nanonis Tremea measurement system

## Flexible, Customizable & Expandable

In a rapidly changing research world the ability to customize experiments is of highest importance, and Tremea comes with a built-in interface which allows for control of the instruments' basic functions from any programming environment. For users requiring more functionality and higher speeds a full-featured LabVIEW-based programming interface or scripting module are available as add-on modules.

Due to the modularity and flexibility of the hardware and software architecture of Tremea upgrades with standardized add-on modules are possible. Non-standard requests can still be handled by the various programming options. That allows the system to grow effortlessly and the user can stay competitive in the scientific research landscape in future benefitting from new features and a reduction in the cost of

ownership. SPECS is the perfect and experienced partner for discussions on new experimental approaches and is able to provide a wide variety of such add-on modules.

## Combining SPM and Quantum Transport Measurements: Tremea Upgrades for Nanonis BP5

The achievement of the best functionality based on 10 years of development in synergy with the market-leading Nanonis Scanning Probe Microscopy (SPM) Control System is taken into account for the Nanonis Tremea software. For customers which have already experience with the Nanonis SPM Control System from SPECS GmbH a Nanonis Tremea upgrade can be purchased to enable the functionality required for quantum transport measurements on the existing measurement system benefitting from new application features.

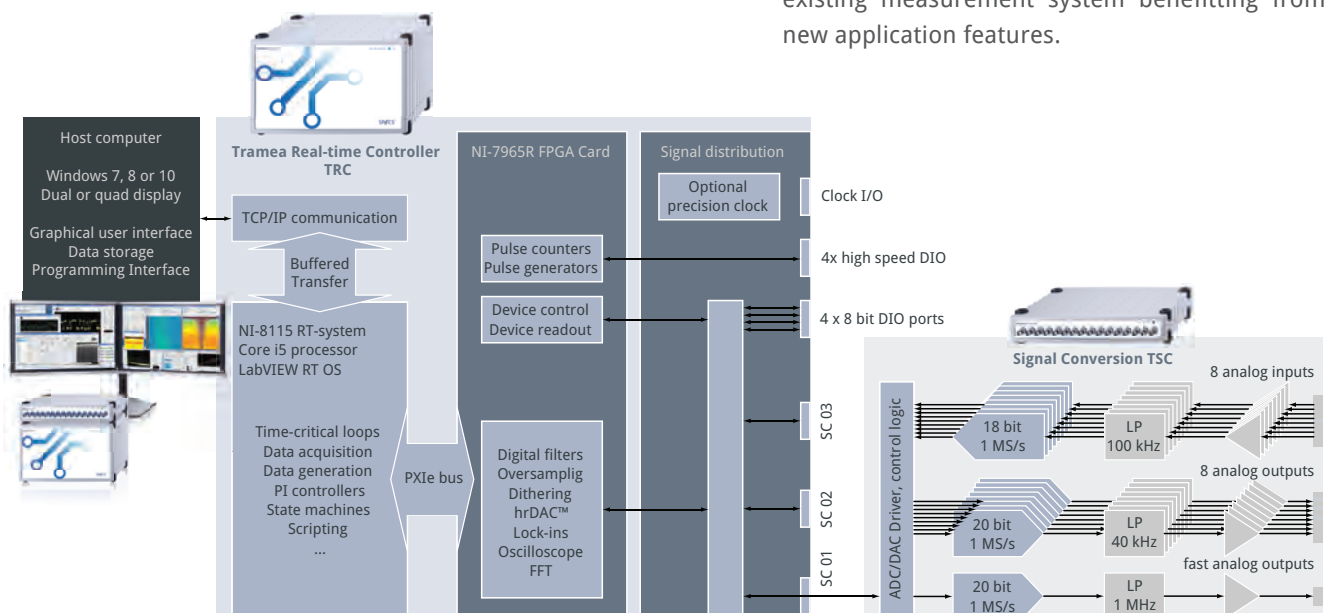

## Applications

### Conductance of a Quantum Point Contact (QPC)

This application for quantum transport measurements shows the conductance of a Quantum Point Contact (QPC) as a function of the gate and bias voltage at low temperatures 2 K. The specimen is a top-gate defined QPC of 800 nm width consisting of a GaAs/AlGaAs heterostructure ( $n=1 \times 10^{11} \text{ cm}^{-2}$ ,  $\mu=4 \times 10^6 \text{ cm}^2/\text{Vs}$ ). The conductance was differentiated mathematically using the Tramea software.

The presented measurement is performed to demonstrate the ultrafast speed of the Nanonis Tramea compared to a conventional set-up. The upper picture was taken with a conventional set-up at a typical measurement speed resulting in almost 12 hours of measurement time for 500.000 points. The middle picture was taken with Nanonis Tramea at a medium speed (also 500.000 points) resulting in 36 minutes measurement time which is 20x faster than the other measurement.

In extreme fast measurements at maximum speed only 2 minutes are sufficient for the same measurement, meaning 360x faster and with reasonable quality (lower picture). Such fast screening possibilities are essential in case that many fast measurements have to be performed on the same specimen. The comparison of the two upper images reveals that artifacts are recognizable in the upper picture which cannot be identified in the middle picture. In addition, the signal-to-noise behavior of the middle picture is much better than on the upper picture where at small amplitudes noise is visible. The reason for that is the unique Tramea design and low-noise performance. Finally, the Nanonis Tramea produces a much better data quality despite significant higher speed was used.

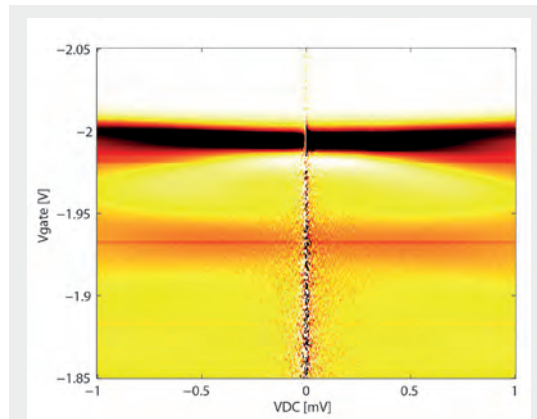

Standard set-up 500.000 measurement points  
(11 h 15 min)

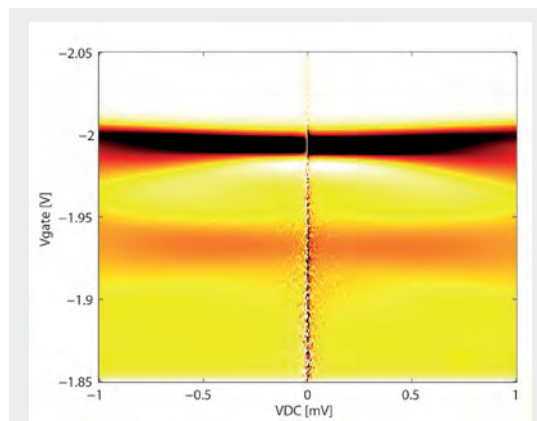

TSC 500.000 measurement points (36 minutes)

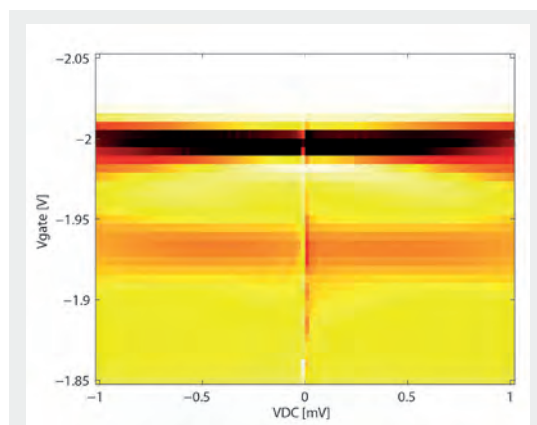

TSC 10.000 measurement points (less than 2 minutes)

Conductance of a 800nm wide QPC as a function of gate and source-drain voltage at 2 K. Data differentiated mathematically.

The much faster measurement (middle image) with Tramea has obviously better quality compared to the slower conventional set-up (upper picture).

The QPC pictures are courtesy of S. Hennel, anophysics group of Prof. Klaus Ensslin, ETH Zurich, Switzerland.

## Hardware performance

### High Resolution AD/DA Conversion

Nanonis Tramea uses the fastest 20-bit, 1-ppm DA-converters available on the market. In the past a similar performance on multiple outputs would have been impossible to realize or would have required a rack full of single-channel instruments.

By the advanced and patented hrDAC™ technology these state-of-the-art converters are turned into real 22-bit devices. Especially for measurements requiring smallest modulations with large offsets are thus possible without the need for analog circuits, external mixers or attenuators which have the disadvantage of introducing additional

drift and errors. The impressive dynamic range also eliminates the need for switching gains. Consequently, the measured values are calibrated and determined over the full signal range. Despite having better DC-performance than most dedicated instruments each output is also AC-capable. The impressive performance is available even for rapidly changing signals, thus combining the ability of arbitrary waveform generators to generate fast voltage ramps with the high precision and resolution of slow dedicated DC sources.

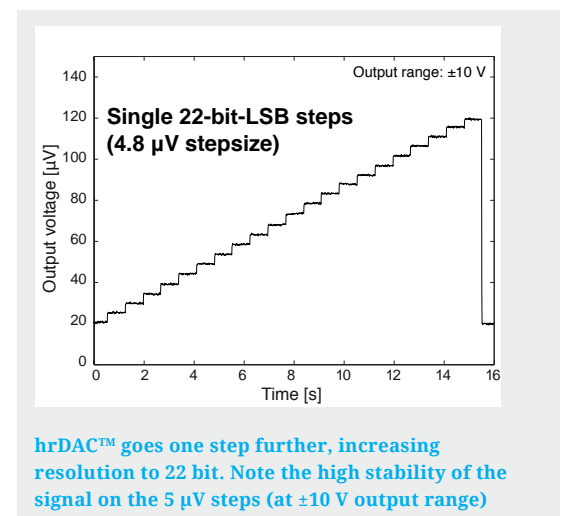
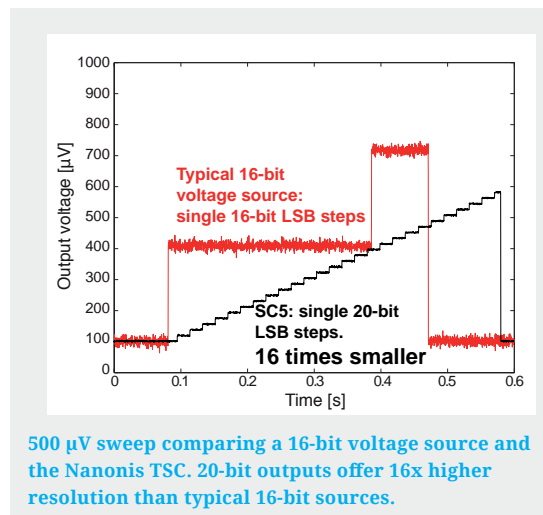



## Adaptive Oversampling for High Resolution Data Acquisition

A tailored input stage allows the acquisition even of the weakest analog signals while using the full available input range of  $\pm 10$  V. Conventional instruments would require gain switching due to their limited dynamic range. The signals are digitized at an early stage with 18-bit AD converters running at 1 MSPS and then processed in the digital domain. This sampling data rate can be applied for time-resolved measurements.

Adaptive oversampling enables always the best Signal-to-Noise performance for a given data acquisition rate. The user does not need to care about adjusting time constants as the data acquisition automatically provides the best setting for a given data rate.

Dedicated instruments for each processing like DC, AC or time-resolved measurements are no longer necessary. The high precision of the inputs paired with the adaptive oversampling method of the data acquisition engine allows measuring data at full 1 MSPS (100 kHz analog bandwidth) in parallel to multi-frequency modulation and accurate DC measurements. All that is possible from a single input.

## Lowest Drift with Temperature Stabilization

Transport measurements can last very long and it is of utmost importance to keep all signals applied to the sample as stable as possible during this time. For this reason the TSC is equipped with a tailored temperature-stabilized and high precision voltage reference. This reference has a very low inherent noise and drift. The outcome of the temperature stabilization combined with thermal decoupling is the decrease of the temperature coefficient to below  $3 \mu\text{V}/^\circ\text{C}$  and the output drift to below  $1.5 \mu\text{V}$  in 12 hours at 0 V output.

## Lowest Output Noise Floor

When experiments require energies of a few  $\mu\text{eV}$  only, then low noise is mandatory besides high resolution. The outputs of the TSC deliver an extreme low noise floor below  $25 \text{ nV}/\sqrt{\text{Hz}}$  with an output voltage range of  $\pm 10$  V. Despite its large bandwidth of 40 kHz, the output noise does not exceed  $10 \mu\text{V}$  rms at a measurement bandwidth of 300 kHz. That means that the noise contribution of the TSC is negligible in all experimental situations.

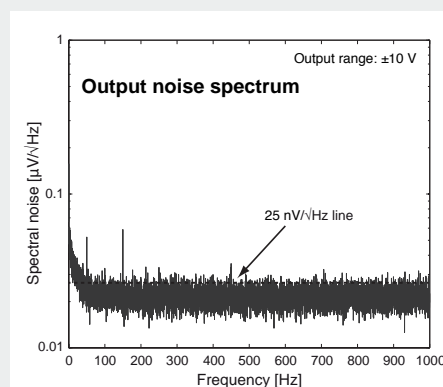

The output noise floor (measured at 0 V) is well below the  $25 \text{ nV}/\sqrt{\text{Hz}}$  line guaranteeing extremely low-noise performance (at  $\pm 10$  V output range)

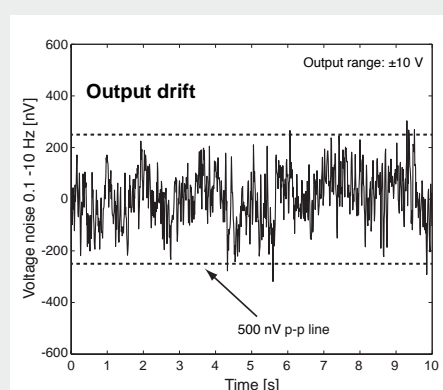

$1/f$  noise is reduced to a minimum resulting in a noise level between 0.1 and 10 Hz close to 500 nV p-p (at  $\pm 10$  V output range)

---

## Lock-in performance

### Lowest 1/f Noise Outputs

In contrast to broadband noise that can easily be filtered, 1/f noise cannot be eliminated and becomes an issue for experiments requiring stable signals. The outputs of the TSC have been designed to bring the noise level much below 750 nV peak-peak (0.1 – 10 Hz,  $\pm 10$  V output range). In other words the noise level is about  $2^{23}$  times smaller than the maximum output signal.

### Digital Inputs and Outputs

32 bi-directional digital lines give sufficient flexibility to read-out and control the Treama and external instruments. Four high speed outputs allow for precise triggering. For high speed counting applications four dedicated lines work with counting rates of up to 100 Mc/s. Nanonis Treama can easily be integrated into clock domains, featuring a 10 MHz clock input with signal autodetect for slave operation and a 10 MHz clock output for master operation. A precise temperature-controlled crystal oscillator can optionally be installed in the system by the user providing an extremely stable and low phase-noise clock source.

### Extreme Dynamic Range

Treama with its TSC module offers exceptional DC performance. Fast sampling out- and inputs allow for transferring this performance into the AC domain without compromise. Any of the precision DC outputs can be used as a modulation output (in addition to DC output) at up to 40 kHz. Any analog input can be used as a demodulation input at up to 100 kHz. As a result the multiple, optional lock-in amplifier modules have not only an unmatched dynamic range but also lowest noise, lowest THD and a very high usable dynamic reserve. The 20-bit outputs and 18-bit inputs enable the accurate measurements of signals as low as 10  $\mu$ V with an input range of  $\pm 10$  V. This is more than 120 dB of linearity. Even the best lock-in amplifiers on the market would require gain switching for reaching this level of performance.

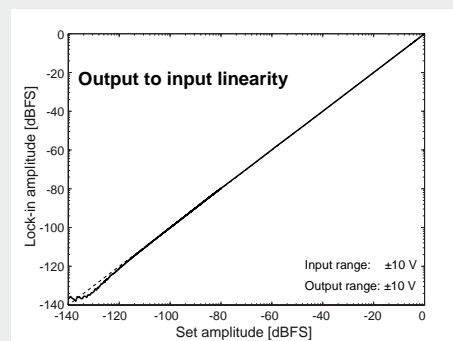

**Linearity of the lock-in module showing 120 dB of usable dynamic range. The measurement is done with  $\pm 10$  V input range meaning that no gain is used. The left part of the plot is measured with an output attenuator in order to avoid limitations of output resolution.**

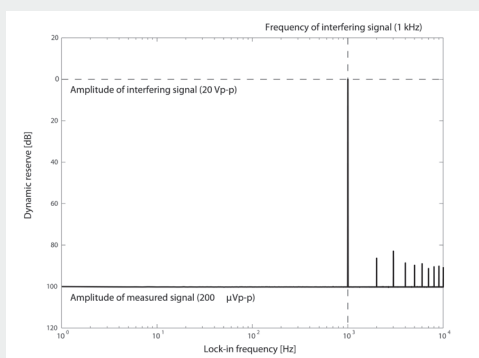

**Measured dynamic reserve with an input signal of 100  $\mu$ V amplitude (input range: 10 V) and with an interfering signal with an amplitude of 10 V at 1 kHz demonstrating 100 dB of suppression. (Harmonics of 1 kHz are due to input distortion components).**

## Advanced Filtering for High Dynamic Reserve

Precise determination of small signals in noisy environments requires effective filtering. The lock-in modules of Tramea provide all required tools for best signal recovery capabilities. Each of eight dual-phase demodulators has independent low-pass filters with a wide range of time constants and filter orders up to the eighth order. The sync filter can be used fully either without additional filtering or in combination with low-pass filters. This is acting over the full bandwidth of the demodulator input (100 kHz). The result is a dynamic reserve above 100 dB and the ability to suppress spurious frequencies even when those are very close to the actual sample signal which is measured.

## Multiple Lock-Ins and Multi-Frequency Package

Each one of the 8 lock-in add-on modules contains one independent signal generator. By this any of the analog outputs of any of the available TSC within a Tramea system can be modulated. It is even possible to modulate the same output with multiple frequencies or demodulate the same input at multiple frequencies. All these techniques are possible without moving a single cable and without compromising the excellent DC performance of the output.

The lock-in modules are available as single, dual, quad or octa-modules providing a flexible solution in case the experiment requirements grow over time integrating new features. For the single- and dual modules a multi-frequency and multi-input option is also available featuring 8 independent demodulators assignable independently to any of the TSC inputs. This solution is ideal for Hall measurements, for multi-frequency measurements or for measurements requiring data to be acquired with different filter settings at the same time.

---

## Software performance

### Concept

Most experiments have been and will be extended over time in the laboratory. This requires mainly to handle a collection of heterogeneous instrument control interfaces. To simplify the ease-of-use the Tramea software provides a superior “one fits all framework” with embedded functionality. The software is expandable for customized experiments using either the existing add-on modules or own user-programmed functions.

### Advanced User Interface

By the state-of-the-art graphical user interface the efficiency is improved thanks to the modern design and workflow optimized solutions. An operation with pre-defined and selected work environments simplifies and handles most complex experiments. For example, depending on the interest of the application only operational tabs and windows are active at the time when the function is needed. The individual user settings like the user interface layout and parameter settings can be stored and recalled quickly for switching between modes and applications of the running experiment.

### Architecture

Tramea software is based on the latest developments in programming techniques and signal processing to provide a more powerful experimental platform. With its modular architecture all data are acquired simultaneously and transmitted to all software instruments at all times. All inputs, outputs, and internal signals are seamlessly accessible throughout the entire Nanonis software. Any signal can be selected in any module for observation, acquisition or noise analysis but without affecting other modules.

## Signal Handling and Signal Safety

For immediate and interpretable quantitative results, signals are displayed in physical units (SI) using a floating point representation. Calibrations take into account external divider or gain stages ensuring that the acquired data do not require any further calibration afterwards. This way the user always gets the actual voltage applied to the sample displayed in the software. Every signal output can be configured in order to be linked by linear combinations to other outputs, if compensation for coupling effects in the sample needs to be considered, for example. The user who has prepared the sample in a time-consuming process can rely on the safety measures of the software so that sample damage is avoided. The software takes this aspect into account providing global limits for output voltages and for slew rates independently for each signal avoiding sample damage.

## Adding Intelligence to your Data Acquisition

Tremea measurement system makes it possible to automatically optimize the signal-to-noise ratios for complex sample configurations benefitting from the intelligent adaptive oversampling. Nanonis Tremea adds an additional degree of intelligence to data acquisition: Measurement speed can be adapted automatically to the actual value and the quality of the input signal. On one hand that results in faster measurements for intervals where no interesting input signal is expected (e.g. just noise). On the other hand high quality data are taken when sample interactions and specific information can be collected. Intelligent adaptive oversampling works on up to four input channels in parallel ensuring best data quality also for complex sample configurations.



High speed 3D-Sweep module.

## Everything Under Control

All signals can be monitored live with versatile displaying options. The Fast Fourier Transform (FFT) spectrum analyzer, various signal charts, oscilloscopes or signal history show continuously the actual status and response of the sample. Such fully digital and integrated software instruments are much more efficient in use, better in performance and lower in capital and maintenance costs than their external counterparts. This is of great value for optimizing the experimental setup, integrating without disrupting the signal and thus improving the quality of the scientific results tremendously.

## Easy Customization

One of the fascinating aspects of scientific research is that research experiments have their own dynamics. That requires high flexibility for the laboratory equipment. Therefore, Nanonis Tramea is sufficiently open to allow researchers access and customization flexibility to save time. Even experiments which have not been done before can be included easy in the generic TCP programming interface. The control of most

functions of the instrument as well as data readout over the TCP/IP interface is possible through the connection of instrument and PC. This interface is not bound to any specific programming language which gives a great opportunity to customize the experiment control via Python, Matlab, C++ or other programming environment.

## Quantum Dot Simulator

The new quantum dot simulator profits from the tight integration of the Tramea architecture so that realistical measurement routines and scripts can be verified offline. The simulation is as good as there would be a real QD connected. A model simulating a quantum dot is inserted between outputs and inputs so that the user can tune a quantum dot and measure the stability diagram. The simulator, a standalone version of the full-featured software, can be freely installed on any PC, thus maximizing the learning effect and minimizing risks for damaging samples. There is a User help to learn about the operation of the system.

Model developed by Prof. T. Ihn, Nanophysics group, ETH Zurich, Switzerland.



## Software add-on modules

### LabVIEW Programming Interface

Competitive advantage in research is often based on the modification of an instrument allowing the researcher to do pioneering experiments. This is where Tramea's LabVIEW Programming Interface shows its strength to efficiently design your experiment. While the generic TCP programming interface provides basic functionality accessible from any programming language the LabVIEW Programming interface additionally offers more functions and more comfort by providing building blocks for important experimental procedures. For instance there is a set of examples available helping less experienced users with programming. Also the integration of third-party instruments within LabVIEW is straightforward. The LabVIEW Programming Interface is a library of functions to remote control Nanonis Tramea, to automate experiments, calibration routines and experimental procedures or to monitor parameters and trigger alarms. It provides full access to everything the LabVIEW offers including debugging capabilities and a fully integrated development environment.

### Scripting Module

For experiments where exact timing and fast execution are crucial the scripting module becomes the ideal tool for customization. Those scripts are executed on the real-time system 20000 times per second in a time deterministic manner. That reduces the response time by a factor of 100 compared to other programming options. The scripts give also full access to analog outputs and digital trigger lines and acquire data directly. They can include loops and "if-then" conditions for complex experimental routines.

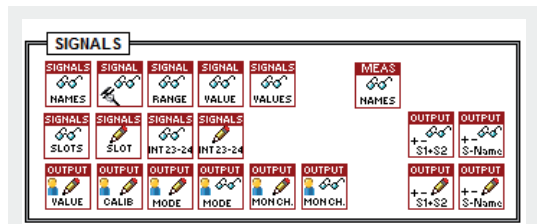

Part of Programm Interface Tree: The LabVIEW Programming Interface provides a comprehensive set of building blocks for customized experimental routines.

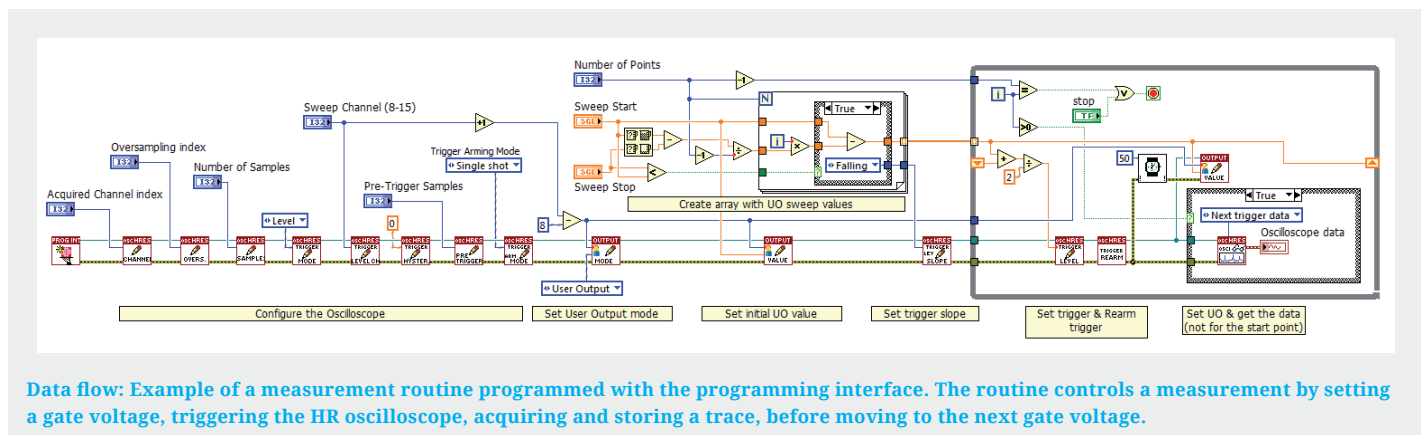

Data flow: Example of a measurement routine programmed with the programming interface. The routine controls a measurement by setting a gate voltage, triggering the HR oscilloscope, acquiring and storing a trace, before moving to the next gate voltage.

## Lock-In Modules

A variety of Lock-in packages offer a maximum flexibility to match the measurement requirements. Lock-in modules available in single, dual, quad or octa versions and defined by the number of frequency generators are listed in the table below.

Module	Name	# of frequency generators	# of demodulators	Demodulators assignable to multiple inputs
Single lock-in	LD-1	1	2	No
Single lock-in with multi-frequency and multi-input option	LD-1MF	1	8	Yes
Dual lock-in	LD-2	2	2+2	No
Dual lock-in with multi-frequency and multi-input option	LD-2MF	2	8	Yes
Quad lock-in	LD-4	4	8	Yes
Octa lock-in	LD-8	8	8	Yes

## High Resolution Oscilloscope and FFT Function Generator

Transport experiments often require acquisition of time-dependent signals with typical time scales are ranging from microseconds to several minutes. The high resolution oscilloscope and FFT module give not only access to data acquisitions with up to 1 MSPS but also work with variable acquisition time and trace lengths of up to 1 million points. The high precision and low noise inputs help to get a high dynamic range for signals without the need of gain switching. Exact timing is guaranteed by a fully configurable triggering system (with pre-triggering option). In parallel to precise time-resolved measurements the FFT function offers very high frequency resolution down to the mHz range.

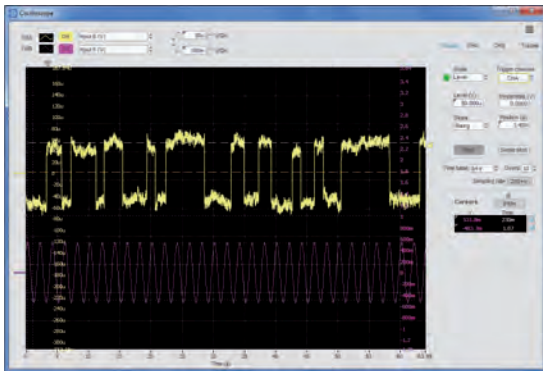

When the same waveform or pulse sequence needs to be applied periodically, a function generator is simpler to use and more efficient than scripts. Just upload any customized waveform and generate periodic patterns with a frequency between 500 mHz and 15 kHz by using the high precision and low-noise 20-bit outputs. For higher slew rates, the function generator can also address the single fast analog output of the TSC offering 1 MHz analog bandwidth.

## Generic PI Controller

This module is an efficient method of adding feedback to the measurement system. This could be used for temperature control or for keeping the sample at its optimal working point. The module works either in DC or AC mode with independent voltage limits for the control output and with a maximum control bandwidth of 6 kHz.

---

## Hardware add-on modules

### Additional TSC

Since the beginning of quantum transport measurements the sample complexity is significantly increased resulting in a higher number of sample electrical contacts. Nanonis Tramea has 8 inputs and outputs using a TSC. This number already serves the majority of applications, offering more channels than conventional measurement systems where doubling the number of inputs or outputs means buying the corresponding number of DC sources or multimeters. For latter the measurement system and in a larger part the measurement software need to be adapted accordingly which decreases the efficiency and changes to the measurement routine. Tramea is a much simpler solution for extending the set-up: Just add one or two additional TSC's to the existing TRC system and the instrument transforms into a 16 inputs and outputs or even 24 inputs and outputs measurement system. The corresponding channels are seamlessly integrated into the software so that there is no change in the workflow and no loss of efficiency.

---

## Hardware design

### Signal Conversion TSC

The electronic mainboard of the TSC is a showcase for the best available active digital and analog electronic components on the market. That is the consequence of meticulously chosen components down to each single resistor ensuring high quality and reliable performance.



## Linear Power Supply and Auxiliary Power Supply

The Trame Signal Conversion (TSC) device is powered by a linear power supply. Switching power supplies or DC/DC converters are avoided in this instrument. Though a linear power supply is present there is no need to manually adjust the line voltage to local circumstances. An intelligent circuit detects the line voltage and automatically configures the power transformer inputs. An auxiliary power supply is available for powering external instruments like pre-amplifiers, for instance. External power supplies are not necessary, because of the low-noise, pre-regulated  $\pm 15$  V power supply output with up to 300 mA current delivery capability of the TSC.

## Real-time Controller TRC

The core of the Nanonis Tramea is Tramea's Real-time Controller TRC. By using the latest Field Programmable Gate Array (FPGA) and Central Processing Unit (CPU) technology the TRC provides enough speed, connectivity and processing power for the most demanding tasks. Both FPGA and real-time modules are easily exchangeable. And the modularity ensures that you can replace a component, if it fails without having to ship back the entire instrument. Communication, triggering and control of additional external instruments is easy thanks to the various digital communication options of the TRC accessible from the software programming modules.



---

Tramea Real-time Controller (TRC)

---

## Technical Data

### Specifications

Real-Time Controller (TRC)	
Dimensions	32.5 x 28 x 21 cm
Weight	7.8 kg
Power supply	Built-in universal power supply, max. 200 W, 100 - 240 V, 50 - 60 Hz
Real-Time System	NI PXIe-8115 real-time system with Intel Core i5 CPU 2.5 GHz, 2 GB RAM
Operating System	NI LabVIEW Real-Time OS
FPGA	NI PXIe-7965R
Connectivity	Up to 3 signal conversion units

Signal Conversion Unit (TSC)	
Dimensions	32.5 x 28 x 7 cm
Weight	4.2 kg
Power supply	Built-in linearly regulated power supply, toroidal transformer, automatic line voltage detection. Max. 51 W, 100 - 240 V, 50 - 60 Hz
Electrical GND	10 k $\Omega$ AGND to chassis, decoupled from TRC

Digital Lines	
Ports	4 x 8 lines on four D-sub 9 female connectors
Signal	3.3 V TTL, max. 25 mA per line
Direction	Input or output for each line
Maximum clock frequency	500 kHz

High Speed Digital Lines	
Ports	4 x inputs and 4 x outputs on SMB male connectors
Signal	3.3 V TTL, max. 33 mA per line
Maximum clock frequency	200 MHz

Clock	
Ports	1 x input, 1 x output for active clock source on SMB male connectors
Frequency	10 MHz, square wave, 3.3 V
Accuracy	$\pm$ 50 ppm (standard clock), $\pm$ 4 ppm (optional OCXO)



Graphical User Interface	
Operating system	Windows XP/Vista/7/8 Windows 7 64-bit recommended
Min. requirements	Intel Core Duo 1.5 GHz or equiv., 2 GB RAM, 100 GB HD, one 24" screen with 1920 x 1200 pixels
Recommended configuration	Intel Core i5 2.5 GHz or better, 8 GB RAM, 1 TB HD, two 21" or larger screens with 1600 x 1200 or 1920 x 1200 pixels
License	Unlimited in time, bound to Real-time controller
Documentation	Online help, F1 for context sensitive help, tip strips for each control element, hardware user manuals (pdf), software operation manual (pdf)
Settings configuration	For every session directory/user, settings, parameters and screen layouts

Signals and Analysis (software modules)	
Signals	48 signals (inputs, outputs and internal signals), up to 24 simultaneous signals for data display and acquisition
Operations Between Signals	+, -, ×, linear combination on real-time system.
Data Transfer	Via TCP/IP, 2 kS/s default, up to 20 kS/s
Representation	32-bit floating point, real world physical units
Oscilloscope	2-channel, up to 20 kS/s, DC, rms, and peak-peak measurements, triggering by level or manual, save/paste waveform per channel, programmable with programming interface
Long Term Spectrum	Power spectral density vs. time as a gray-scale plot. Dedicated spectrum viewer
Signal Charts	Continuously rolling charts with adjustable speed
Signal History	All 48 signals in memory for the last 2.5 s to 7 hrs
Long-Term Chart	Record signals over hours to days

Software Module	
Generic sweeper	Sweeps outputs, setpoints, various parameters, integration time 10 ms – 10s

### Analog Inputs (all specifications for ±10 V input range)

Hardware Interface	8 x BNC connectors, differential; upgradable to 24
Diff. Input Voltage Range	± 10 V
Diff. Input Impedance	2 MΩ
Analog Bandwidth	DC – 100 kHz (-3 dB), 5th-order Butterworth low-pass filter
AD-Converter	18-bit, monotonic, 1 MS/s
Effective Resolution	20-bit @ 60 kS/s, 22-bit @ 1 kS/s (oversampling)
INL	± 2 LSB typical
DNL	± 1 LSB typical
Input Noise Density	< 150 nV/√Hz @ 10 kHz, < 650 nV/√Hz @ 10 Hz
Measurement Noise	< 100 μVrms @ 1 MS/s, < 25 μVrms @ 60 kS/s, < 6.5 μVrms @ 240 S/s
12 h-Drift	< 80 μV (< 100 μV) @ 0 V (@ 9.9 V)
THD+N, 9 V Input Signal	>120 dB @ 100 Hz, >95 dB @ 1 kHz, > 70 dB @ 10 kHz

### Analog Outputs (all specifications for ±10 V output range)

Hardware Interface	8 x BNC connectors, referenced to AGND; upgradable to 24
Output Voltage Range	±10 V into 1 kΩ or larger (0 to +10 V with internal jumper per channel)
Output Impedance	< 1Ω, short circuit safe
Analog Bandwidth	DC – 40 kHz (-3 dB), 5th-order Butterworth low-pass filter
DA Converter	20-bit, 1-ppm precision, 1MS/s
Effective Resolution	22-bit, patented hrDAC™ technology with active glitch compensation
INL	< ±2 LSB max. ±1 LSB typical
DNL	< ± 1 LSB max. < ±0.5 LSB typical
Output Noise Density	< 25 nV/√Hz @ 100 Hz, < 75 nV/√Hz @ 1 Hz
Output Noise	< 180 nVrms (0.1 – 10 Hz), < 10 μVrms (10 Hz – 300 kHz)
12h-Drift	< 1.5 μV (< 25 μV) @ 0 V (@ 9.9 V)
THD+N	>93 dB @ 100 Hz, > 93 dB @ 1 kHz, > 79 dB @ 10 kHz (for 18 Vp-p output signal)

Fast Measurement Engine (software module)	
Acquisition channels	1-24
Sweep channels	Any analog output
Data samples	2 – 1M (per measurement)
Sample rate	Up to 20 kS/s. 50 $\mu$ s to 20 s integration time per point
Timing	initial settling time, settling time, integration time, slew rate, intelligent oversampling
Intelligent oversampling	Settings for up to 4 input channels simultaneously. 4 user-selectable signal ranges, SNR, standard deviation or fixed integration period, individually per signal range.
Point spacing	Continuous, variable resolution
Data display	Data file viewer (standalone application), binary file viewer (standalone application)
Data format	ASCII (routines for LabVIEW, Matlab, Octave provided)

High-Resolution Oscilloscope and Spectrum Analyzer (software add-on module)	
Sampling rate	1 MS/s
Resolution	18-bit @ 1 MS/s, 22-bit @ 1 kS/s
Analog bandwidth	100 kHz
Triggering	Automatic, Level, Manual on analog inputs, outputs and digital inputs or outputs
Pre-triggering	Up to 8000 trace points
Trace length	32 – 1'000'000 points
Measurement time	32 $\mu$ s – 17 minutes
Oversampling	1x – 1024x
FFT	Up to 500'000-point
Frequency resolution	Up to 1 mHz
Waveform handling	Save/paste. Continuous saving upon triggering
Measurements	DC, RMS, peak-peak, peak height, peak spacing
Programming	Over Programming Interface

Lock-In Amplifiers (software add-on module)	
Number	Up to 8 independent dual-phase lock-in amplifiers
Modulation frequency range	100 mHz - 40 kHz
Demodulation frequency range	100 mHz – 100 kHz
Frequency resolution	10 nHz
Phase resolution	22 fRad
Demodulators	Up to 8 dual-phase demodulators assignable to any carrier frequency. Multi-demodulator operation per carrier (multifrequency) or on multiple inputs possible.
Demodulator harmonic	1 - 32
Demodulator filter cut-off frequency	100 mHz – 20 kHz
Demodulator filter slope	6, 12, 18, 24, 30, 36, 42, 48 dB/oct
Demodulator output resolution	32-bit
Demodulator output data rate	1 MS/s (Sync off), carrier frequency (Sync on)
Sync filter frequency range	100 mHz – 40 kHz
Linearity	120 dB
Dynamic reserve	> 100 dB

Other Software Modules (software add-on module)	
PI controller	Discrete PI controller, DC and AC operation, bandwidth 6 kHz
Function generator	Arbitrary user-defined waveform loaded over look-up table with 20-bit resolution. Repetition rate of 0.5 Hz to 15 kHz

Specifications subject to change without notice.

---

**SPECS** Surface Nano Analysis GmbH  
Voltastrasse 5  
13355 Berlin / Germany  
[www.specs.com](http://www.specs.com)

T +49 30 46 78 24-0

F +49 30 46 42 083

E [Nanonis.Tramea@specs.com](mailto:Nanonis.Tramea@specs.com)

**SPECS**<sup>TM</sup>