

KolibriSensor™

ADVANCED QUARTZ SENSOR TECHNOLOGY
FOR FM-AFM

KEY FEATURES

- Sensitive and Fast
- Reliable
- Adjustment-Free
- Simultaneous AFM & STM
- Nano Manipulation
- AFM in Liquids
- Kelvin Probe Microscopy



SPÉCS™



INNOVATION IN SURFACE SPECTROSCOPY AND
MICROSCOPY SYSTEMS

**SPECS leads the way in state-of-the-art
technology for electron spectroscopy and
scanning probe microscopy.**

SPECS Surface Nano Analysis GmbH

SPECS headquarters with more than 150 employees is located in the center of Germany's capital Berlin, with subsidiaries in Switzerland (SPECS Zurich GmbH) and in the USA (SPECS Inc.). Furthermore, we have liaison offices in France and Spain and are represented all over the globe by our sales partners.

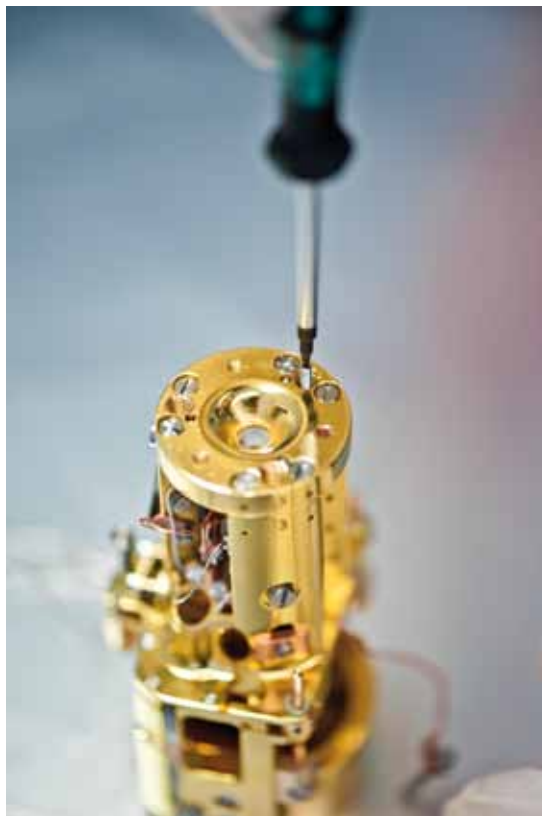
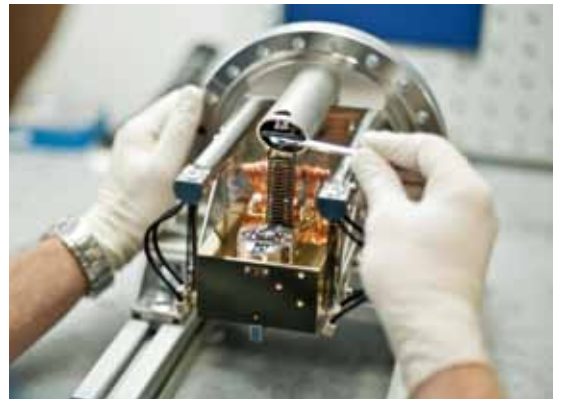

State-of-the-art scanning
probe microscopy systems

We are a team of scientists and engineers who have been dedicating their knowledge and experience to the development, design, and production of instruments for surface science, materials research, and nanotechnology since 1983.

Our key to success is know-how, experience, close contact to scientists from all over the world, customer orientation, reliable quality control, and dynamic research and development.

Frequency Modulation Atomic Force Microscopy

Frequency modulation atomic force microscopy (FM-AFM) is a powerful scanning probe technique to image a large variety of surfaces on length scales ranging from several micrometers to the atomic scale using a tip as a probe. FM-AFM is based on the measurement of quantities related to tip-sample interaction forces. A mechanical oscillator - characterized by its spring constant k , eigenfrequency f_0 , and quality factor Q - is used as a force sensor. The tip is part of the oscillating mass m .

In FM-AFM, the force sensor is driven to oscillate with constant amplitude A ; resonance is imposed via the phase relation between the excitation force and the tip oscillation. The oscillation frequency f of the force sensor depends on tip-sample forces. The basic measured quantity in FM-AFM is the frequency shift Δf of the force sensor, defined as the difference between the oscillation frequency f with the tip subject to interaction forces and the eigenfrequency f_0 .

The mechanical tip oscillation is converted to an electrical signal (deflection detection). The frequency shift is measured by frequency demodulation with a phase-locked loop (PLL).

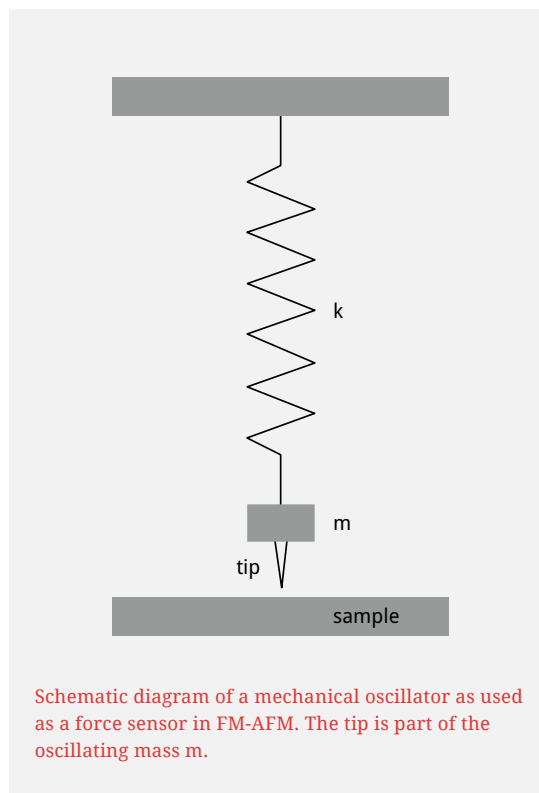



ADVANCED QUARTZ SENSOR TECHNOLOGY
FOR FM-AFM

The KolibriSensor from SPECS is a quartz sensor for simultaneous FM-AFM and STM. It features excellent signal-to-noise ratio. It is simple to operate and reliable.

The KolibriSensor is manufactured employing a sophisticated micro-fabrication process. Individually tested and specified, the KolibriSensor is a reliable plug-and-play SPM sensor with outstanding performance.



Advanced Quartz Sensor Technology for FM-AFM

The KolibriSensor combines great force sensitivity with high acquisition speeds. It is self-actuating and self-sensing. It is compatible with powerful tip preparation techniques. With its great simplicity and high reliability, it allows the researcher to focus on the experiment, not the force sensor. Fast. Symmetric. Lasting. A true Kolibri.

Sensitive

The KolibriSensor is the most sensitive quartz based AFM sensor

Higher Force Sensitivity

The piezo electromechanical coupling constant of the KolibriSensor is about ten times higher than that of typical quartz tuning forks, the 1 MHz resonance frequency of the KolibriSensor is on the order of 30-50 times higher. This results in a remarkably low deflection noise floor of less than 1 fm/√Hz with the external KolibriPreamp™. This key advantage of the KolibriSensor results in faster data acquisition and higher resolution. Even with its high spring constant of 540 kN/m, the KolibriSensor has a signal-to-noise ratio an order of magnitude better than typical tuning fork setups when measuring the force gradient (for the same Q factor and oscillation amplitude). This surprising and experimentally verified result is due to the KolibriSensor's very strong deflection signal.

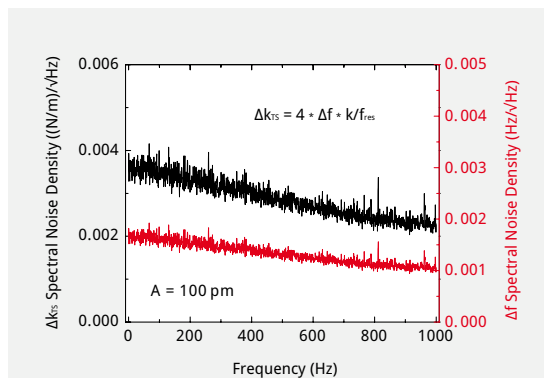

Spectral noise density of the force gradient Δk_{fs} in the free-oscillation regime measured at room temperature. $A = 100$ pm, $Q = 27,000$, $k = 540$ kN/m. The bandwidth of amplitude and phase loop was 50 Hz and 100 Hz, respectively.

Smaller Amplitudes

Oscillation amplitudes may be set below 20 pm. The high spring constant of the KolibriSensor enables stable oscillation, the low-noise deflection detection a good frequency shift signal even at small amplitudes. Small amplitudes are favorable for high-resolution FM-AFM and are a prerequisite for simultaneous STM and AFM.

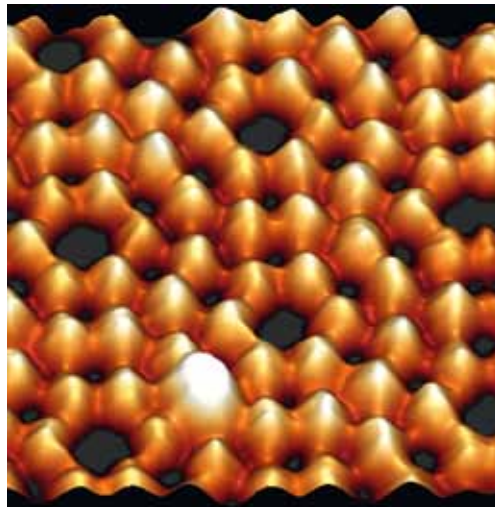

25 s / frame

FM-AFM image of the Si(111) (7x7) surface acquired at room temperature with an Aarhus SPM. $A = 200$ pm, $\Delta f = -0.3$ Hz, 5 nm x 5 nm, 256 x 256 Pixel

Higher Q Factor

The KolibriSensor is based on a symmetrical length extension resonator. The center of mass remains at rest and reaction forces are compensated inside the quartz with minimal losses. Very high Q factors, resulting in low frequency noise and high force sensitivity, are achieved independently of the sensor mount.

Fast

FM-AFM imaging was never as fast as with the KolibriSensor

Increased Scanning Speed

The slow scanning speed achieved when using typical silicon cantilevers or tuning forks for UHV FM-AFM with acquisition times of several minutes per frame is a severe limitation in many applications. The KolibriSensor with its high resonance frequency of 1 MHz and excellent signal-to-noise ratio overcomes this limitation. It enables faster data acquisition in FM-AFM imaging and force spectroscopy. Atomic resolution FM-AFM is now possible with unprecedented acquisition times below one second per frame, even on insulating substrates. The KolibriSensor facilitates rapid characterization of surface topography on large scales at astonishing scanning speeds.

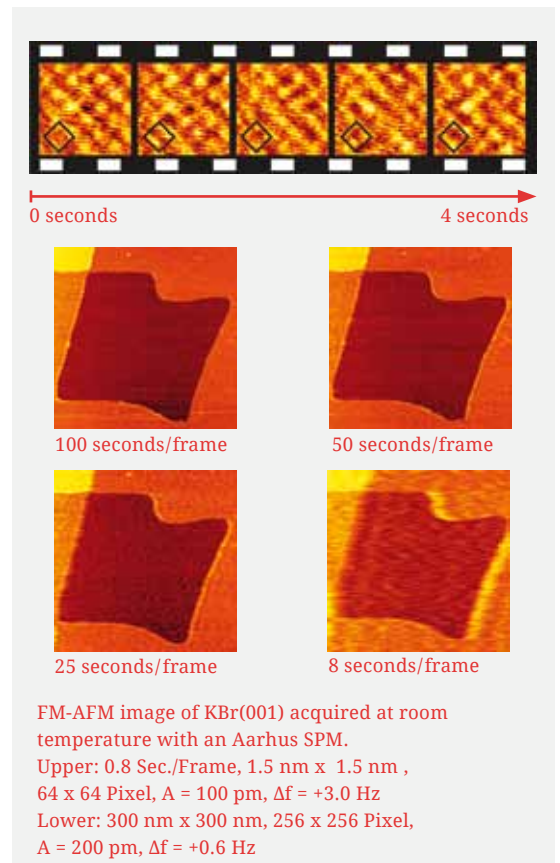

Accurate

FM-AFM and STM – Simultaneous, and Each at its Best

With small oscillation amplitudes, the KolibriSensor enables simultaneous STM and FM-AFM. For acquisition of the tunneling current, the KolibriSensor's metal tip is provided with a separate electrical contact, which guarantees clean separation of STM and AFM signals. The KolibriSensor is also excellent for conventional STM with non-oscillating tip.

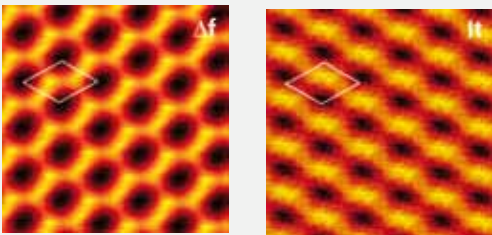

Constant height images on Au(111) of the frequency shift Δf and the tunneling current I_t , acquired simultaneously with a KolibriSensor and an Aarhus SPM at room temperature, $A = 300$ pm.

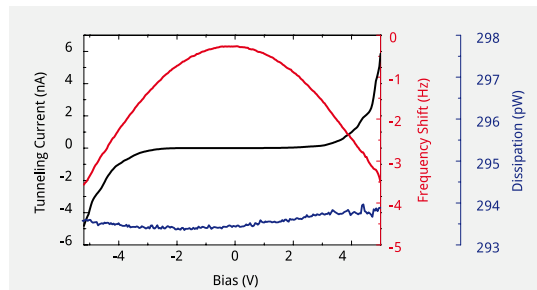

Frequency shift, tunneling current and dissipation on Si(111) (7x7) acquired simultaneously as a function of bias at room temperature with an oscillation amplitude $A = 300$ pm.

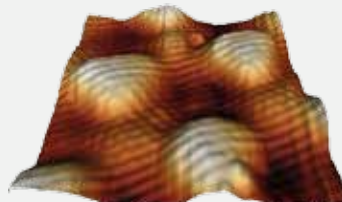

Constant current STM image of graphene on Ru(0001) acquired with a KolibriSensor with oscillating tip and an Aarhus SPM at room temperature. $U = +0.7$ V, $I_{\text{set}} = 50$ pA, $A = 100$ pm

FM-AFM at Small Distances

With its extraordinary force sensitivity, the KolibriSensor is excellent for high-quality atomic-resolution FM-AFM imaging on various surfaces including insulators. The sensor's stable oscillation at small amplitudes enables imaging in both the short-range attractive (negative Δf) and repulsive (positive Δf) tip-sample interaction regime.

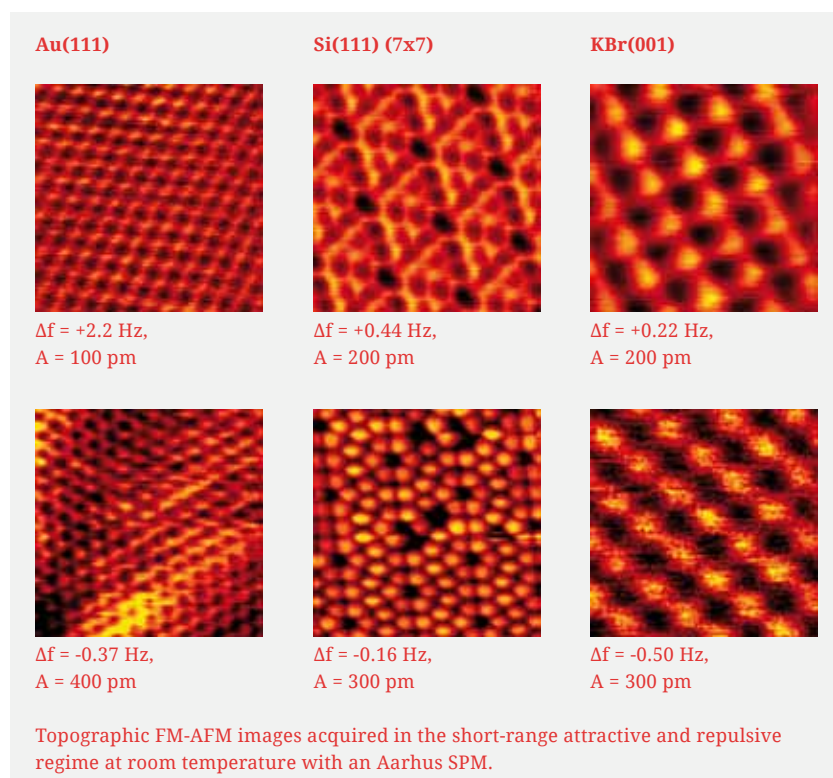

Spectroscopy

With its well defined electrical characteristics, the KolibriSensor is the ideal sensor for quantitative spectroscopy studies. What is more, with its ability to simultaneously acquire force and tunneling data, it is the ideal sensor for quantitative studies of relationships between different tip-sample interaction mechanisms. For instance, it is possible to simultaneously measure the frequency shift, the dissipation, the tunneling current, and the differential tunneling conductance.

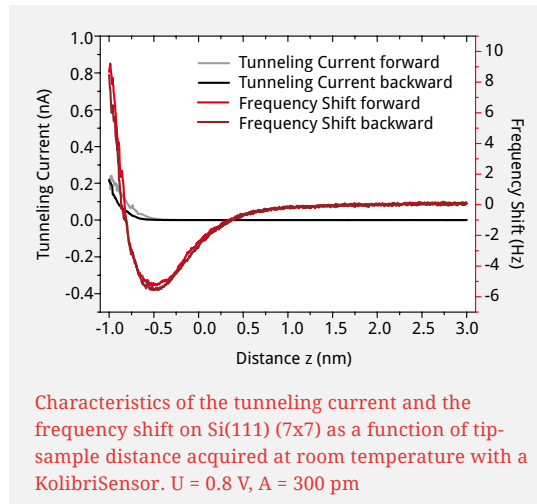

Dissipation Measurements

With the KolibriSensor, quantitative dissipation measurements are easy and accurate. No calibration is necessary since the dissipated power is directly related to the units of Volt and Ampere. Dissipation of force sensor oscillation energy arises, when the tip-sample interaction force as a function of distance exhibits hysteresis. Dissipation provides valuable information in many contexts.

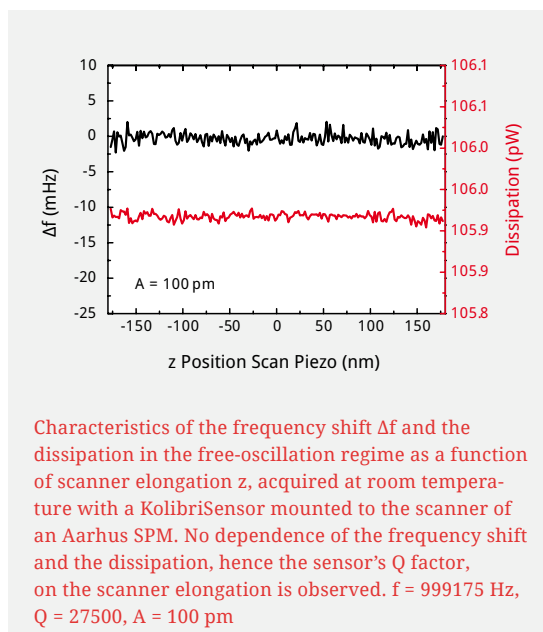

Well Defined Oscillation

The design of the KolibriSensor ensures an oscillation of the tip perfectly aligned with its longitudinal axis. In particular, there is no tilted oscillation as is typical for cantilevers and some tuning fork implementations. The direct piezoelectric excitation avoids excitation of lateral modes. Due to the symmetric layout of the quartz resonator, mechanical interactions between the sensor oscillation and the sensor mount are minimized. High Q factors are reproducibly achieved independent of the sensor mount and elongation of a scanner.

Versatile

The KolibriSensor excels in various applications of SPM

Force Mapping

Ideal for rapid acquisition of force-distance characteristics, the KolibriSensor is an excellent choice for measuring 2-D and 3-D force volume data.

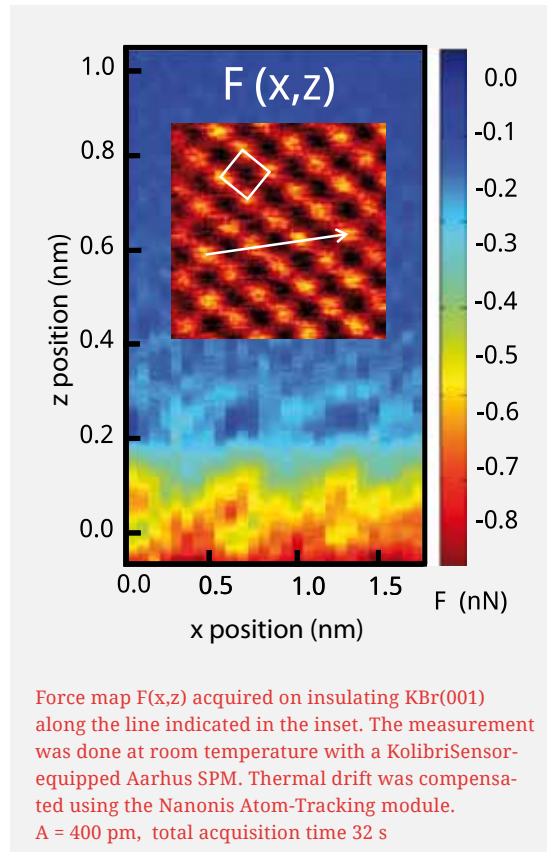

Kelvin Probe Force Microscopy

The local contact potential difference (CPD) relates to many surface phenomena, including catalytic activity, reconstruction of surfaces, and local charge distribution. The metallic tip of the KolibriSensor makes it an ideal probe for measuring the local CPD by bias spectroscopy and frequency modulation Kelvin probe force microscopy (FM-KPFM).

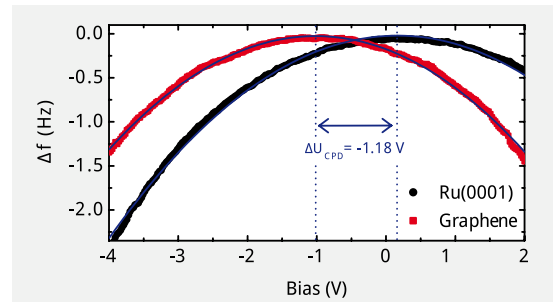

Bias spectroscopy atop graphene and Ru(0001) surface sites measured at room temperature with an Aarhus SPM.

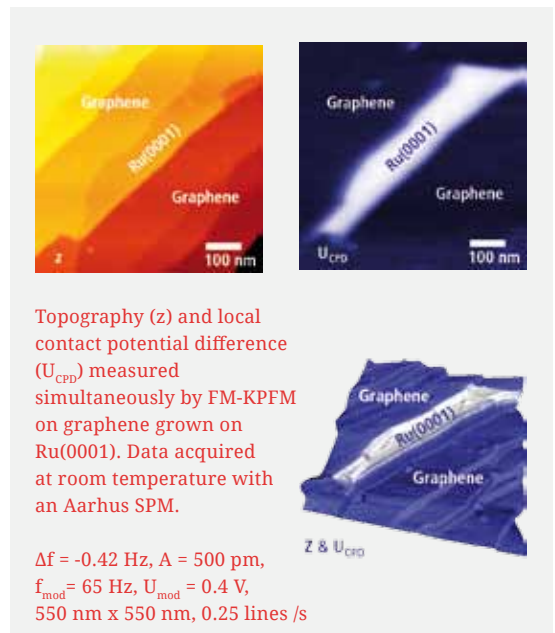

SPM in Liquids

The KolibriSensor is protected by a sophisticated metal casing. The tip protrudes to the outside through a hole with a diameter of only 100 μm . The tip can be immersed in water without water entering the casing, the sensor's Q factor remains large. Since solely the tip is oscillating in the liquid while the sensor's casing and base are at rest, no spurious peaks are present. The high Q factor and excellent noise floor below 1 fm/ $\sqrt{\text{Hz}}$ makes the KolibriSensor an excellent force sensor for SPM in liquids. The KolibriSensor enables highest-resolution FM-AFM in liquids with unprecedented ease of use.

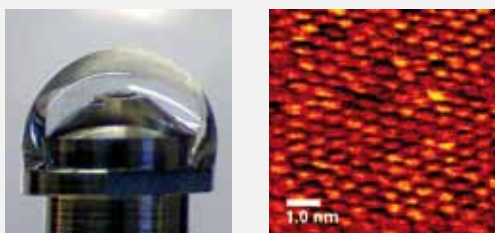

Surface of cleaved muscovite imaged in 1 M KCl buffer solution by FM-AFM with a KolibriSensor. Data acquired with an Aarhus SPM modified for imaging in liquids. $A = 300 \text{ pm}$, $\Delta f_{\text{set}} = +140 \text{ Hz}$

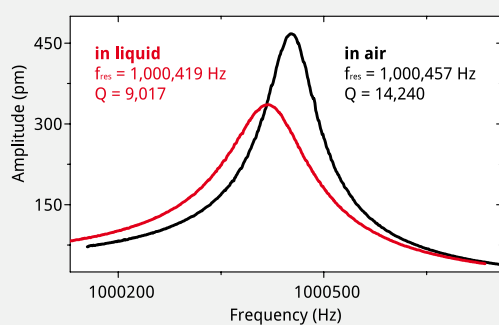

Frequency response of a KolibriSensor with the tip oscillating in air (black) and in water (red), measured with an Aarhus SPM modified for imaging in liquids.

Low Temperature Operation

The adjustment-free, completely electronic self-sensing deflection detection makes the KolibriSensor ideal for low temperature applications where there is limited space, adjustment of optics would be complicated or where complete darkness is important. The typical power dissipation of an oscillating KolibriSensor is on the order of Picowatts only.

FM-AFM image of Si(111) (7x7), acquired at low temperature. $T = 2.4 \text{ K}$, $A = 69 \text{ pm}$, $Q = 80,000$, $\Delta f = -1.3 \text{ Hz}$. Courtesy of Toshu An, group of Prof. Hasegawa, The University of Tokyo.

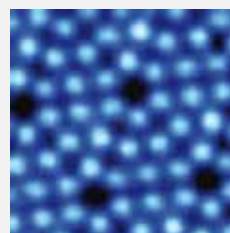

Upgrade your STM to FM-AFM

The KolibriSensor features entirely electric excitation and deflection detection based on the piezoelectric properties of quartz. No external actuators are required for excitation. Deflection detection is adjustment-free. An excellent signal-to-noise ratio is achieved with the external KolibriPreamp. Therefore, retrofitting existing (low temperature) STM systems with a KolibriSensor for combined STM and FM-AFM is quick and easy.

Reliable

KolibriSensor is commercially available with guaranteed performance

Scanning electron micrograph of the KolibriSensor tungsten tip protruding from the sensor's metal casing.

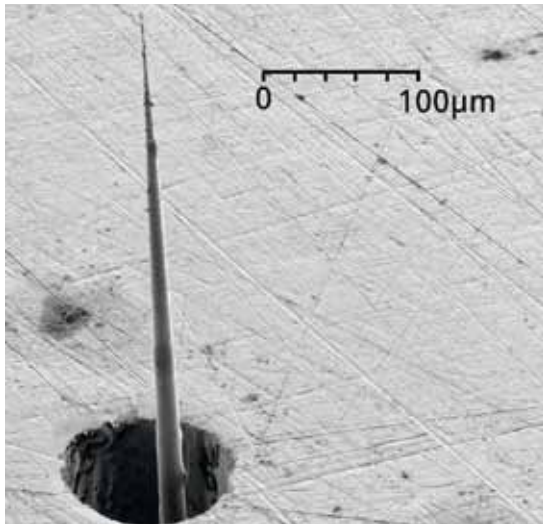

Guaranteed Performance

The KolibriSensor's high quality standard is achieved by employing a sophisticated micro-fabrication process, developed in collaboration with the Swiss watchmaking industry. Each sensor is tested at the factory. Resonance frequency and Q factor are documented and provided on a specification sheet.

Metallic Tip and Metallic Shielding

The KolibriSensor is completely enclosed in a sophisticated metal casing, only the sharp etched tungsten tip protrudes outside through a tiny hole. The rugged casing not only simplifies handling. It provides electromagnetic shielding, it limits crosstalk, it enables scanning capacitance microscopy and powerful tip preparation techniques.

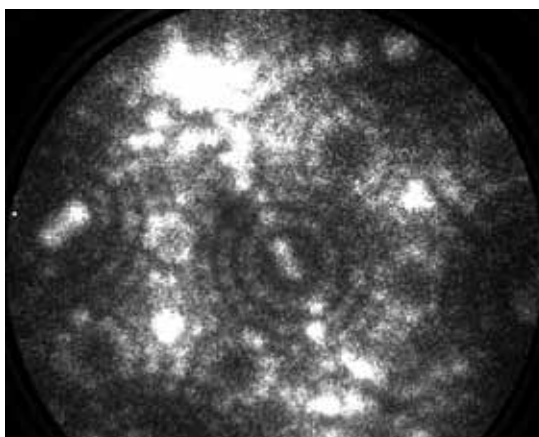

FIM image of a polycrystalline KolibriSensor tungsten tip, measured at a tip bias of $U = 3$ kV with the tip held at room temperature.

Powerful Tip Preparation

The sensor's metal casing enables simple and powerful in-situ tip preparation and sharpening by parallel ion beam sputtering, field ion microscopy (FIM), field emission and evaporation. Parallel ion beam sputtering is an extremely powerful preparation technique for tungsten tips. It results in sharp, clean and oxide-free tips favorable for highest-resolution STM and FM-AFM imaging. Also blunt tips or tips contaminated after prolonged imaging on bulk insulators or molecular films can be restored by sputtering. As its tip can be sputtered many times, a KolibriSensor has a very long life.

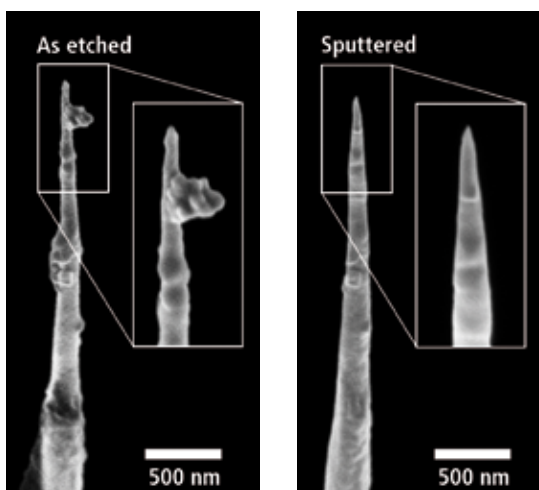

Scanning electron micrographs of the same tip, before and after sputtering with a parallel oriented Ar^+ ion beam (acceleration voltage 3.8 kV).

SPECS KolibriPreamp™

Highest Performance Deflection Detection

With the new KolibriPreamp, the oscillation of the KolibriSensor can be detected with unprecedented precision. The noise floor is below 1 fm/√Hz, one order of magnitude lower than achieved with traditional current-to-voltage converter setups and lower than achieved with even the best interferometric detection systems. With the KolibriPreamp, users of the

KolibriSensor can obtain lower frequency noise, enabling faster scanning speeds and smaller oscillation amplitudes. The KolibriPreamp was developed by FEMTO® Messtechnik GmbH and takes advantage of their excellent know-how and experience with preamplifiers. Excellent characteristics are achieved also with relatively long wiring distances between the KolibriSensor and the KolibriPreamp's input. In UHV systems, the KolibriPreamp is operated outside the vacuum chamber. The KolibriPreamp combines lowest-noise deflection detection with the great ease of use and reliability of external electronics. The KolibriPreamp seamlessly integrates with the Nanonis Oscillation Controller.

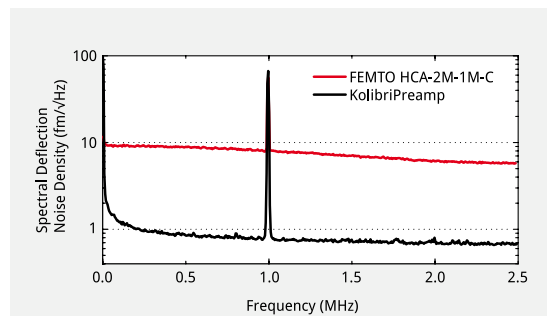

Spectral deflection noise density measured with the FEMTO HCA-2M-1M-C (red), a current-to-voltage converter, and the SPECS KolibriPreamp (black). Both measurements were conducted under identical conditions at room temperature with a KolibriSensor oscillating at an amplitude of $A = 10$ pm and an Aarhus SPM.

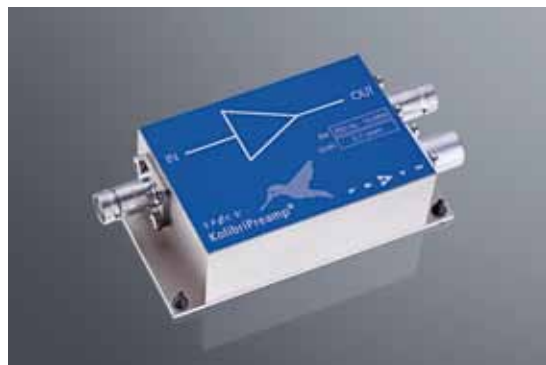

KolibriPreamp

KolibriPreamp Specifications

Bandwidth (-3dB)	250 Hz to 15 MHz
Gain	0.7 V/nm, 10 V/pC
Noise Floor	< 1.0 fm/√Hz
Max. Oscillation Amplitude	7 nm
Output/Input Impedance	50 Ω/1 GΩ @DC
Supply Voltage/Current*	±15 V/ ±100 mA
Power Supply Connector*	LEMO 1S, 3 Pin Fixed Socket

*The SPECS KolibriPreamp is fully supported by the Nanonis Oscillation Controller.

KolibriReceptor™

Precise Kinematic Mount

The KolibriReceptor is a precise kinematic mount with reliable electrical contacts for the KolibriSensor. It is fully UHV, low temperature, and high magnetic field compatible, and can be directly used as a building block in advanced scanning probe microscope designs. The lightweight design allows direct mounting to a scanner. The snap-in mechanism allows inserting and removing the sensor with a wobble stick or even with the coarse positioning system of the SPM.

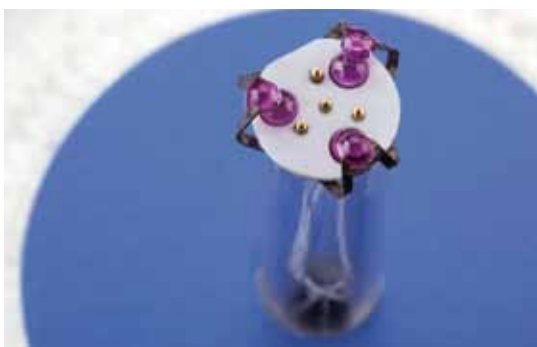
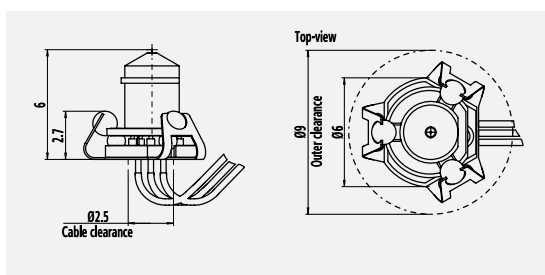

KolibriReceptor

SPECS KolibriReceptor Specifications

Springs	CuBe
Baseplate	Al ₂ O ₃
Spring Contacts	CuBe Gold plated
Weight	0.12 g
Cables	3 x copper coax, ø 0.35 mm, l = 30 cm

KolibriSensor Starter Kit

Getting Started

SPECS provides a plug-and-play starter kit comprising all components required to learn more about sensor operation and handling.

The starter kit contains:

- Three KolibriSensors (native)
- SPECS KolibriPreamp
- Test stage with KolibriReceptor
- Special tweezers to handle KolibriSensors
- Low noise cabling for direct connection of the Nanonis Oscillation Controller
- Stand-alone Nanonis Oscillation Controller



Test stage with
KolibriReceptor

KolibriSensors in Various Forms

KolibriSensor is available in various adaptations for different systems

KolibriSensor Bruker Adapter Kit

SPECS provides a plug-and-play kit comprising all components needed to start imaging with Bruker MultiMode® SPMs.

The kit includes:

- Three KolibriSensors (Native)
- SPECS KolibriPreamp
- Bruker Adapter with KolibriReceptor
- Special tweezers to handle KolibriSensors
- Low noise cabling for direct connection of the Nanonis Oscillation Controller

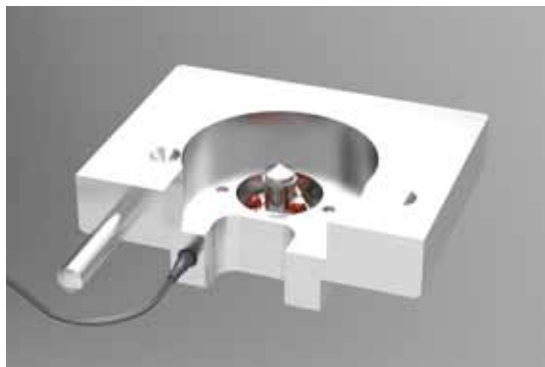

Bruker Adapter with KolibriReceptor fitting the Bruker MultiMode SPM head. Cable: 3x copper coax, \varnothing 0.35mm

Screwmount KolibriSensor

The Screwmount option provides a convenient way for mounting and electrically contacting the KolibriSensor by means of three screws (M1.6).

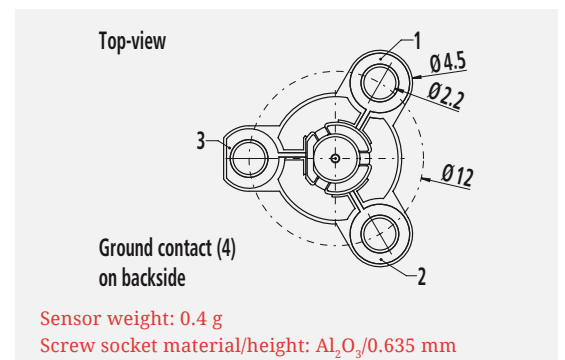

KolibriSensor for Aarhus SPM

The KolibriSensor for the SPECS Aarhus SPM features a socket for clamp insertion. Direct cabling to the sensor is provided.

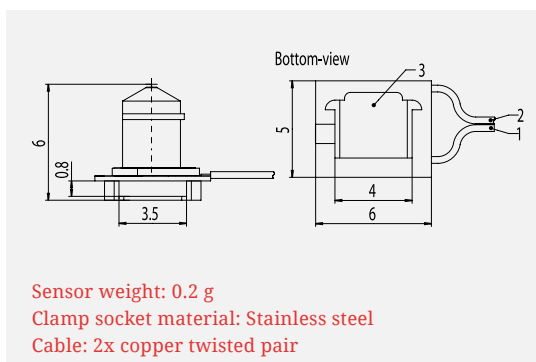

KolibriSensor for Tyto™ SPM

The KolibriSensor for the SPECS Tyto SPM is designed for manipulation with a wobble stick.

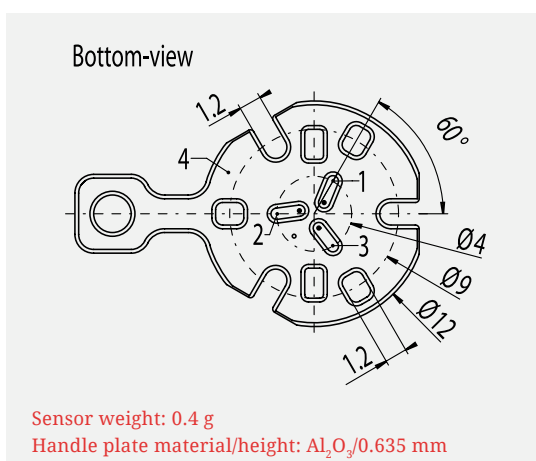

Native KolibriSensor

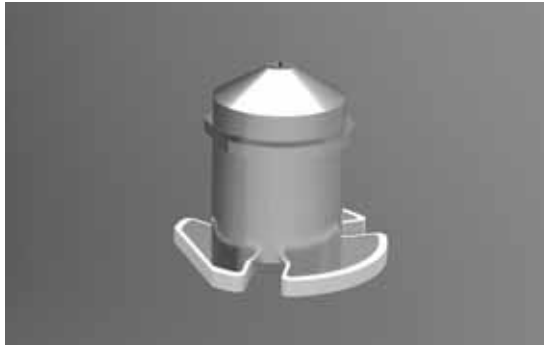

SPECS KolibriSensor Specifications

Resonance Frequency	1 MHz
Q Factor	10,000 – 100,000
Tip Material/Weight	Tungsten/1 μg
Spring Constant	540 kN/m
Piezo Coupling	65 $\mu\text{C}/\text{m}$
Noise Floor	< 1 fm/ $\sqrt{\text{Hz}}$
Typical Oscillation Amplitude	100 μm

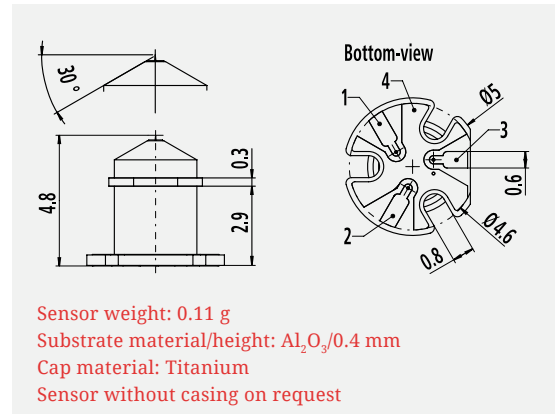

Nanonis Oscillation Controller for the Finest Control of the KolibriSensor

The Nanonis Oscillation Controller provides a convenient and proven way to drive the KolibriSensor. It affords both high-stability amplitude control and low-noise frequency demodulation in a single device fully integrating with the Nanonis SPM Control System. The Nanonis Oscillation Controller features ultra-low input noise, extreme frequency stability and highest frequency resolution essential to take full advantage of the KolibriSensor. The control parameters for amplitude control and frequency demodulation are user accessible and can be auto-tuned using the unique perfectPLL™ algorithm.

Complete SPM Solutions from SPECS

For complete high-performance SPM solutions incorporating KolibriSensor technology please refer to our separate brochures on the proven Aarhus SPM family offering extreme stability, speed, and highest productivity on a daily basis in the temperature range of 90 K to 400 K (1300 K optional), or the revolutionary SPECS ultra-low temperature microscope JT-SPM with lowest cryoliquid consumption for atomic manipulation and highest-resolution spectroscopy at temperatures down to below 1 K with ^4He (below 500 mK with ^3He optional) and optionally in magnetic fields up to 3 T.

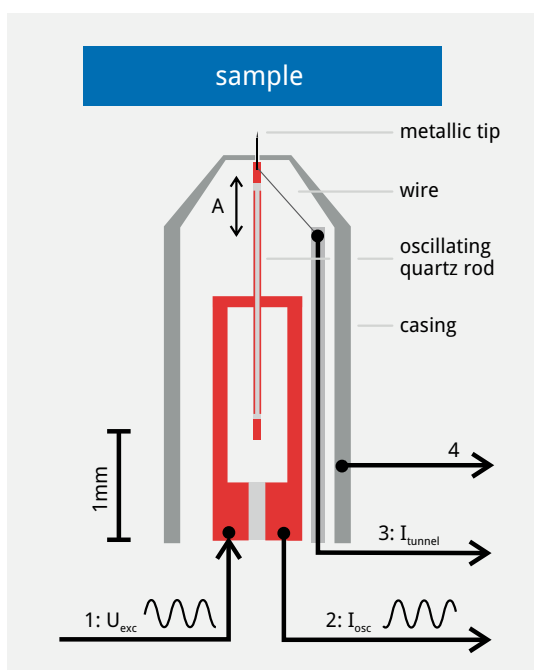

Schematic Drawing

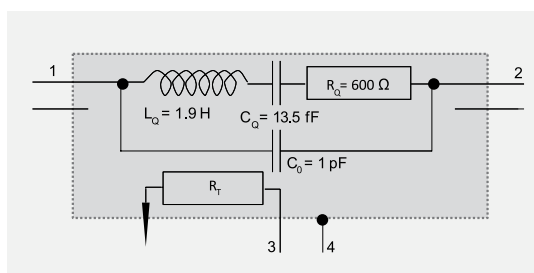

Equivalent Circuit

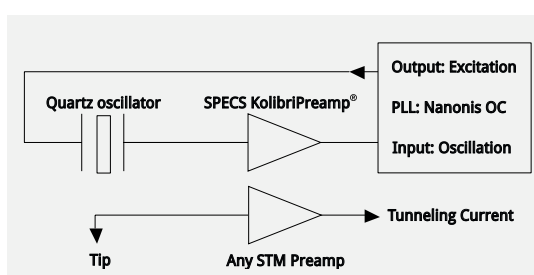

Recommended Instrumentation

SPECS Surface Nano Analysis GmbH
Voltastrasse 5
13355 Berlin / Germany
www.specs.com

T +49 30 46 78 24-0

F +49 30 46 42 083

E info@specs.com

SPECSTM